



ROHDE & SCHWARZ

Operating Manual

TEST RECEIVER

ESH 3

335.8017.52

Printed in West Germany

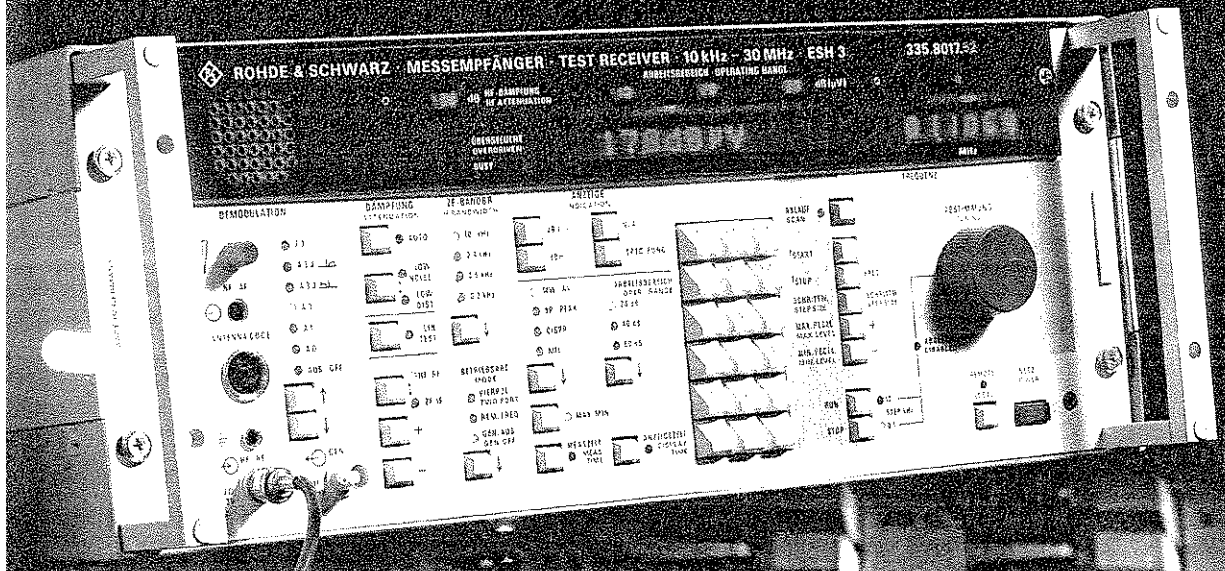

TEST RECEIVER ESH 3

Bus

9 kHz to 30 MHz
-30 to +137 dBµV

RF-RF
 ZF-IF
 BETRIEBSART MODE
 VIERPORT TWO PORT
 REM-FREQ
 GEN. AU
 GEN. EN

50 PEAK
 CISPB
 MIL
 50 dB

MAX MIN

CHARACTERISTICS, USES

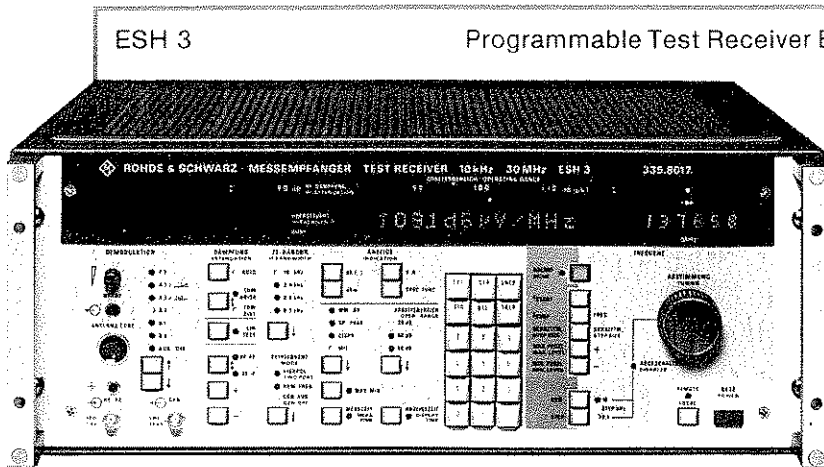

◆ 9 kHz to 30 MHz
-30 to +137 dB μ V

- Field-strength measurements in conjunction with test antennas
- Radio-interference (EMI) measurements to CISPR, VDE and FCC regulations
- Interference (EMI) measurements to MIL and VG regulations
- Radiomonitoring, remote frequency measurements
- Selective voltage measurements in laboratory and test department

IEC 625 Bus

The **Test Receiver ESH 3** demodulates and measures AM double-sideband, single-sideband, PM and FM signals, as well as sinusoidal and impulsive interference, over the range 9 kHz to 30 MHz. High overload capacity, wide dynamic range, manifold measuring and evaluation capabilities, and numerous available accessories make the ESH 3 suitable for selective voltage and two-port measurements – also in automatic test systems – and for all applications in the field of **radiomonitoring** (page 5) and **EMC** (electromagnetic compatibility – EMI measurements – page 4).

Selective voltmeter. Its wide measurement range of -30 to +137 dB μ V permits the use of the Test Receiver ESH 3 as an automatic **high-precision** selective voltmeter in the labo-

ratory, test department and service workshop without any accessory units. For high-impedance test items the Active Probe ESH 2-Z2 can be supplied. The Clamp-on RF Current Probe ESH 2-Z1 is available for measuring RF current in electric conductors. Excellent receiver selectivity makes it possible to measure signals of large level differences to a high degree of accuracy even when there are many signals present. Possible applications: SSB two-tone measurements, measurement of harmonics, non-harmonic spurious signals and sideband noise on generators, intermodulation and crossmodulation measurements on RF modules. In all these applications the ESH 3 can be set either to low-noise or low-distortion measurement. Automatic linearity testing permits an inherent non-linearity to be distinguished from that of the test item.

Other features

- Synthesizer-based design offers frequency setting and readout to crystal accuracy – resolution 100 Hz
- Automatic frequency scanning with selectable start and stop frequencies and step sizes – recording of measured results on printer and/or XY recorder (VDE/FTZ/MIL chart paper can be used)
- Accuracy in compliance with CCIR recommendations
- Automatic calibration of level and frequency offset measurements; frequency response and bandwidth correction values are automatically taken into consideration, making for optimum speed and accuracy of level measurements
- Automatic measurement of voltage, field strength, current, pulse spectral density, and two-port attenuation, with indication of respective physical unit; conversion factors for probes and test antennas and bandwidth correction values are automatically taken into consideration
- Digital data output in μ V to V, dB μ V, dBm and corresponding units for current field strength, and pulse spectral density
- High overload capacity, outstanding overall selectivity, **automatic indication when overdriven**; automatic linearity test triggered at the push of a key
- Programmable measuring times of 5 ms to 100 s for average-value and peak-value indication; determination of RF input level variation (MAX./MIN. as in cases where fading occurs) with programmable measuring times
- Two-port and remote frequency measurement capability
- Additional signal evaluation capabilities: frequency-offset, modulation-depth and frequency deviation
- Storage of 9 complete device settings and 5 range limits for automatic frequency scanning; stored contents and last device setting are preserved when the receiver is switched off or the current supply is interrupted
- Remote-control interface conforming to IEC 625-1 (IEEE 488) for universal application; Talk-Only Mode for data output to IEC(IEEE)-bus-compatible printer without using a controller

CHARACTERISTICS, USES

Calibration generator. The calibration generator output providing $80 \text{ dB}\mu\text{V} \pm 0.5 \text{ dB}$ into 50Ω at receiver centre frequency is ideally suited for measuring the frequency response of amplifiers and filters. The attenuation measurement range extends to 110 dB and the gain measurement range to 57 dB. The RF Current Probe ESH 2-Z1 permits easy measurement of the **shielding effectiveness** of cables. The **return loss** of two-terminal networks (e.g. antennas) and of four-terminal networks can be measured with the calibration generator in conjunction with a VSWR bridge.

In the remote frequency mode it is possible to connect a frequency counter to the generator output for exact (remote) frequency measurement of the signal received by use of the reversion principle.

Signal evaluation

- **Four switchable IF bandwidths:** 0.2/0.5/2.4/10 kHz
- Average, peak and pulse weighted (CISPR Publ. 1 and 3) indication with programmable measuring times
- Switch-selected demodulation modes **A0, A1, A3, A3J (USB, LSB), F3** - built-in loudspeaker and phones output
- **Analog indication** of level and frequency offset in addition to the **digital data output**
- Indication of RF input overload or overloading of other essential stages and automatic **linearity test** at the push of a key
- **Broadband 75-MHz IF output** for connection of panoramic adapter or spectrum analyzer
- **Narrowband 30-kHz IF output** for connection of oscilloscope
- AM and FM demodulator outputs
- Recorder outputs for level and frequency offset
- **Generator output** for signal frequency measurement
- Digital measurement of modulation depth, frequency offset and deviation

Recording of results. Spectra of harmonics, non-harmonic spurious signals and sideband noise as well as gain and

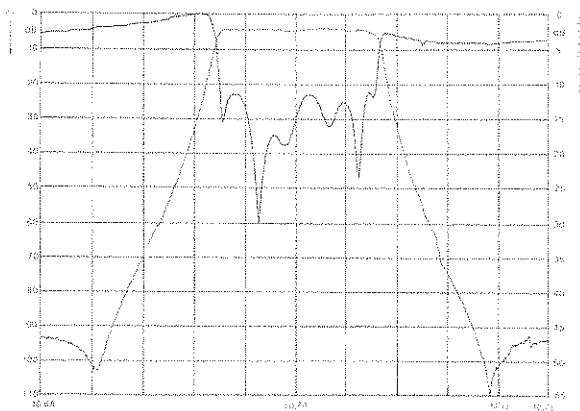

Fig. 1 Insertion and return loss of a crystal filter.

attenuation curves can be readily output on an XY recorder (Figs. 1 and 2). The start and stop frequencies and maximum and minimum levels set on the ESH 3 define the recorder writing area. The frequency axis can be either linear or logarithmic. VDE/FTZ/MIL or the user's own chart paper can be used.

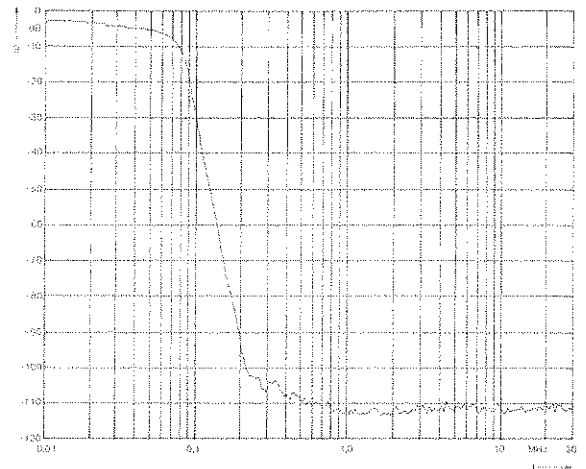

Fig. 2 Attenuation curve of a low-pass filter.

Remote control. The **IEC(IEEE)-bus interface** is provided with all standard listener and talker capabilities. The capabilities of commercially available controllers (Fig. 3) have, however, also been taken into consideration, i.e. it is also possible, for example, to use controllers without serial and parallel poll capabilities.

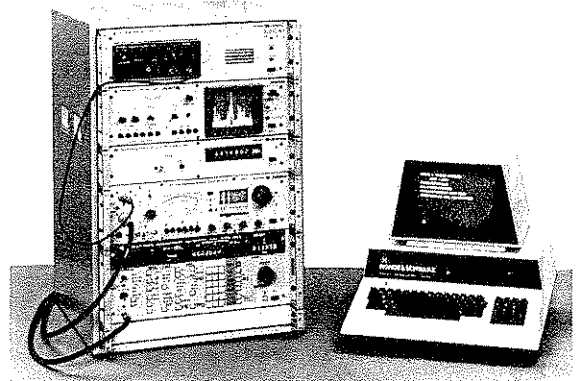

Fig. 3 Automatic test system for 9 kHz to 1000 MHz, measurement range -30 (-10) to $+137 \text{ dB}\mu\text{V}$, consisting of Test Receiver ESH 3 (at bottom), Programmable VHF-UHF Test Equipment MSUP, and Process Controller PPC.

CHARACTERISTICS, USES

Interface functions:

Device Clear resets all functions to a predefined state.

Device Trigger starts test run at exactly defined time.

Local Lockout disables the front panel during automatic test run.

Talk-Only Mode outputs measured data without using a controller.

Interference measurements. In the field of interference measurements the ESH 3 offers considerable advantages over earlier test receivers, featuring programmable automatic frequency scanning and data logging with **direct control** of a printer or XY recorder. The following accessories are available for measuring interference voltages, currents and field strengths to the applicable standards (CISPR, VDE, MIL, VG, FCC):

RF Current Probe	ESH 2-Z1
Active Probe	ESH 2-Z2
Passive Probe ¹⁾	ESH 2-Z3
Artificial Mains Network (LISN) (9 kHz to 30 MHz) ²⁾	ESH 2-Z5
Rod Antenna	HFH 2-Z1
Loop Antenna	HFH 2-Z2
Inductive Probe	HFH 2-Z4

(See also Accessories for Programmable Test Receiver ESH 3, Data sheet 303 203.)

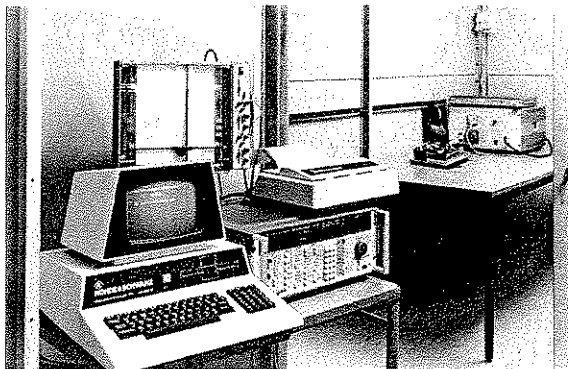

Fig. 4 Automatic measurement of interference voltage with programmed phase switchover (Test Receiver ESH 3, Printer PUD, XYT Recorder ZSKT, Artificial Mains Network (LISN) ESH 2-Z5, Process Controller PPC, and Code Converter PCW). Door to test item open for demonstration purposes.

As interference in the frequency range 9 kHz to 30 MHz is mainly propagated along lines (conducted), interference voltage and current measurements are of major importance (Figs. 4 to 6). In addition to data logging on a printer or XY recorder the ESH 3 offers the following advantages for measuring interference:

- Probe or test antenna conversion factor automatically taken into consideration and indication of appropriate physical unit
- Bandwidth correction factor automatically taken into consideration when measuring pulse spectral density to MIL and VG standards; readout of measured data in $\text{dB}\mu\text{V}/\text{MHz}$, $\text{dB}\mu\text{A}/\text{MHz}$ and $\text{dB}\mu\text{V}/\text{m} \cdot \text{MHz}$

¹⁾ To VDE 0876 regulation.

²⁾ To VDE 0876 regulation, CISPR Publ. 3 and FCC requirements.

- Peak-value indication with programmable hold time for broadband interference measurements to MIL and VG standards
- Average-value indication with programmable integration time for measuring narrowband interference
- CISPR indicating mode with determination of peak value within programmed measuring time
- Programmable measuring times ensuring optimum adaptation of automatic measurements to time-dependent variations of the interference
- Automatic selection of weighting to CISPR depending on frequency (CISPR 3 for 9 to 149.9 kHz and CISPR 1 for 0.15 to 30 MHz)
- 60-dB operating range: ideal for measurements to MIL and VG standards
- 20-dB operating range: for measurements to CISPR, automatic selection of measurement range and consideration of CISPR settling times ensuring errorfree measurements
- Selectable logarithmic frequency scale for data output on XY recorder, permitting direct recording of measured data on tolerance charts

Since the characteristic of broadband noise spectra is a continuous curve, frequency scanning in constant linear or logarithmic steps is possible and appropriate. Each single value, especially with CISPR weighting, is measured with due consideration of the overall settling time (charging and discharging time constant, time constant of low-pass filter simulating meter response).

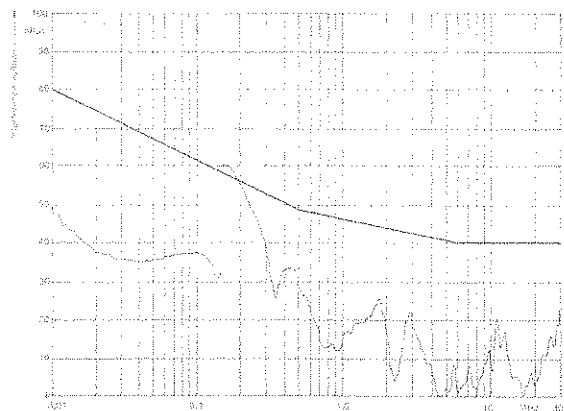

Fig. 5 Interference voltage of commercial desk-top calculator, measured in conjunction with Artificial Mains Network (LISN) ESH 2-Z5 (indicating mode: CISPR). Tolerance curve to FTZ regulation 529/1970 (limit levels for general approval).

Besides these final measurements, the ESH 3 in conjunction with the Active and the Passive Probe, RF Current Probe and inductive Probe is also suitable for **investigating noise sources** and testing suppression measures. The generator output of the ESH 3 permits **attenuation measurements on two-port networks** up to 110 dB so that the effectiveness of RF cable screens and other shieldings, and the attenuation of interference suppression filters can be measured.

CHARACTERISTICS, USES

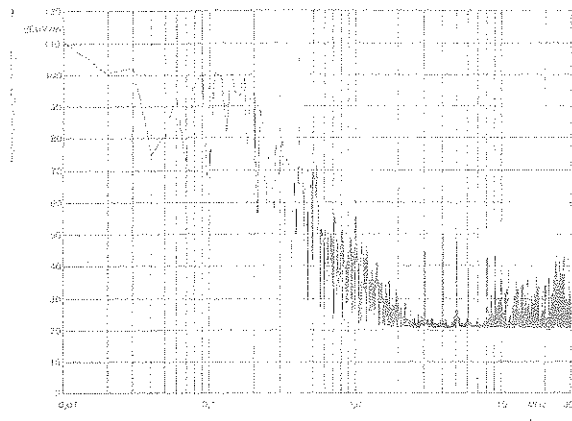

Fig. 6 Interference field strength of a commercial desk-top calculator, measured in conjunction with Loop Antenna HFH 2-Z2 in a screened room at 1 m from test item (indicating mode: average value, IF bandwidth: 10 kHz, step size 10 kHz).

Radiomonitoring. Its outstanding RF characteristics, such as high setting accuracy, high overload capacity and overall selectivity, selectable IF bandwidths and demodulation modes, the wide range of available test antennas and recorders as well as programmability make the ESH 3 suitable for all radiomonitoring tasks including remote frequency measurement, recording of frequency band occupancy and propagation and coverage measurements. It offers the following possibilities:

- Graphic representation of field strength of selected frequency bands either in form of a line spectrum or as a continuous curve on an XY recorder plus output of measured field-strength level and; for example, of modulation depth on a printer (Figs 7 to 11).

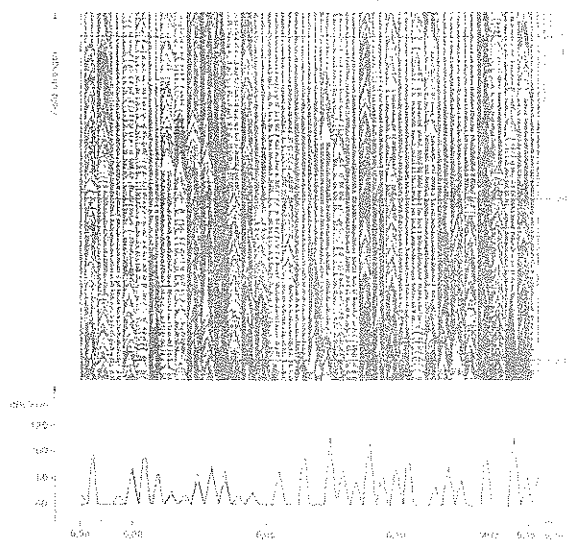

Fig. 7 Recording of 49-m band on Recorder ZSKT; XYT representation (above) and XY representation (below).

```

STRT 0.5400MHz
STOP 1.6020MHz
STEP 0.0090MHz
MAX 120.0dB*
MIN 40.0dB*
    
```

```

SF 11: dB*
SF 21: m
SF 50: SINGLE
SF 52: LINSTEP
SF 60: X-LIN
SF 71: DISCRET
    
```

0.5490MHz	55.9dBuV/m	75%
0.5760MHz	59.6dBuV/m	70%
0.5940MHz	46.5dBuV/m	25%
0.6390MHz	53.6dBuV/m	9%
0.6660MHz	57.6dBuV/m	61%
0.7200MHz	72.7dBuV/m	86%
0.7560MHz	50.0dBuV/m	13%
0.8010MHz	108.4dBuV/m	37%
1.0170MHz	44.0dBuV/m	95%
1.0260MHz	50.5dBuV/m	40%
1.0440MHz	46.6dBuV/m	71%
1.1070MHz	101.3dBuV/m	68%
1.1970MHz	94.9dBuV/m	4%
1.4220MHz	53.1dBuV/m	61%
1.5390MHz	52.8dBuV/m	54%

Fig. 8 Printout of automatic frequency scan over medium-wave range (ESH 3 in Talk-Only Mode, Universal Printer PUD with IEC(IEEE)-bus Interface in Listen-Only Mode).

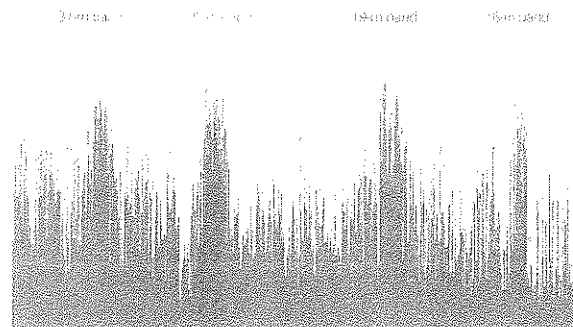

Fig. 9 Line spectrum of short-wave range (sound broadcasting bands clearly recognizable).

- Measurement of range of variation of field-strength level within a preset measuring time (1 to 1000 s).
- Recording of field strength as a function of time on YT recorder (Fig. 14), for example, on board a helicopter to determine the horizontal and vertical radiation patterns of transmitting antennas.

Examples of applications continued on page 8.

TEST RECEIVER ESH 3

FRONT PANEL DETAILS

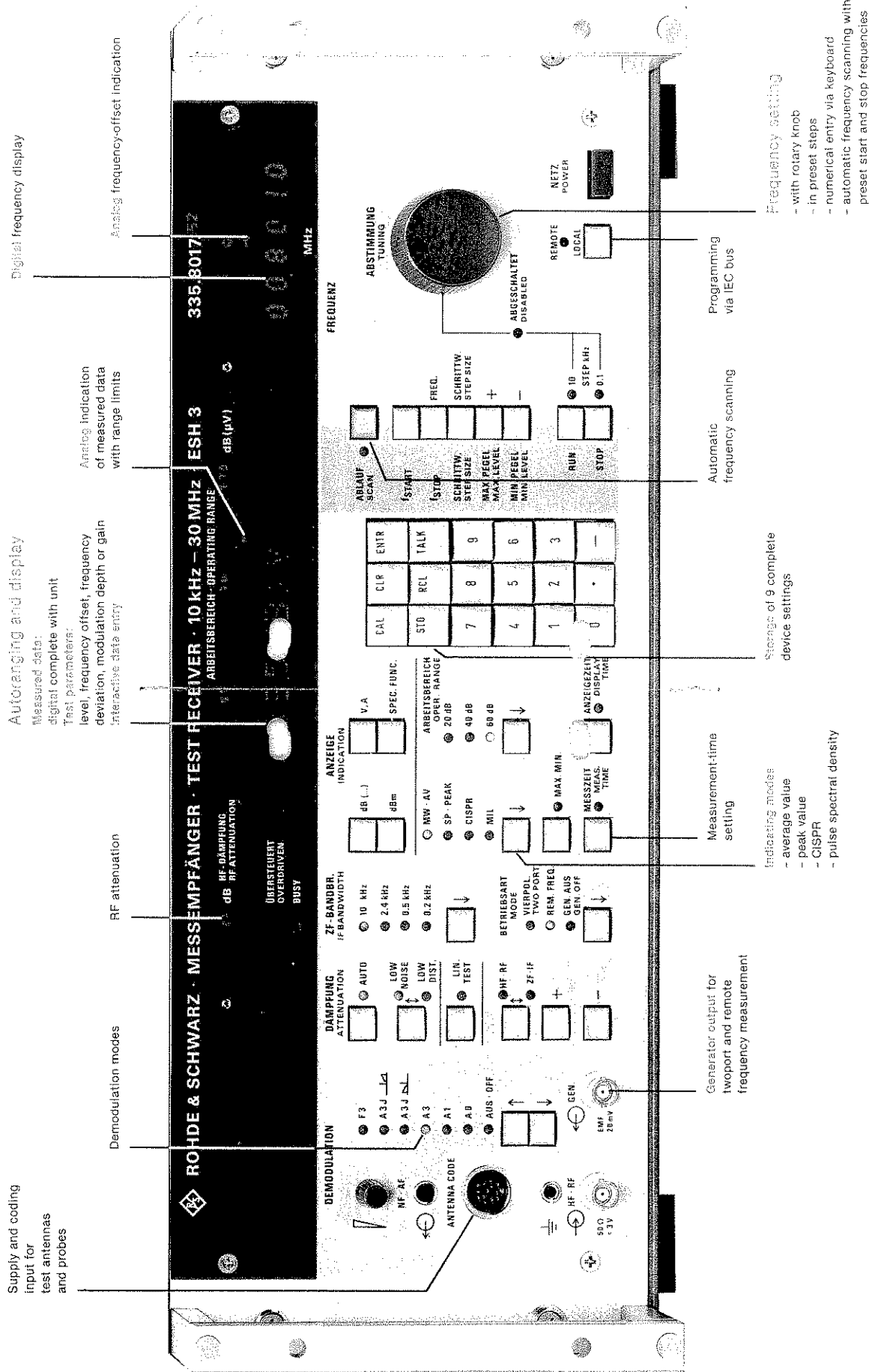

USES

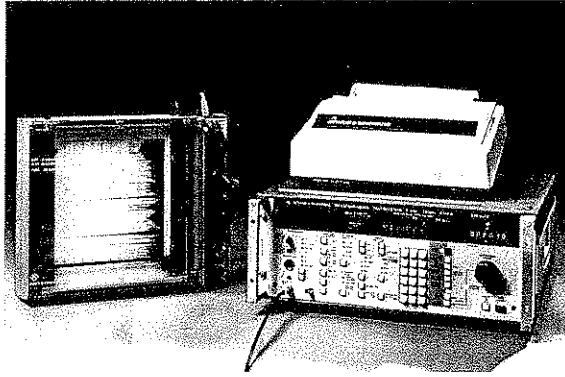

Fig.10 XYT Recorder ZSKT, Test Receiver ESH 3 and Universal Printer PUD.

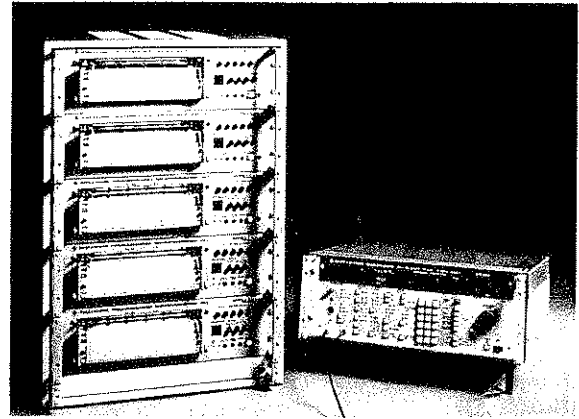

Fig. 13 ESH 3 with five Radiomonitoring Recorders ZSG 3 for scanning five different frequency bands and plotting the band occupancy.

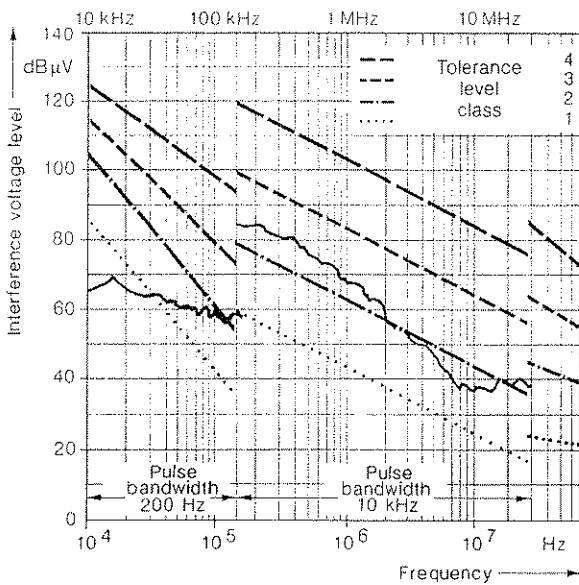

Fig.11 Broadband interference (peak value) measured with the ESH 3 and plotted on VG chart paper on XY recorder.

• **Recording of frequency-band occupancy** as a function of time on the Radiomonitoring Recorder ZSG 3. When the signal level exceeds the preset threshold level (= MIN. LEVEL) the recorder traces a dash (Fig. 12). The ESH 3 can drive up to five Radiomonitoring Recorders ZSG 3 in a sequential cycle (Fig. 13).

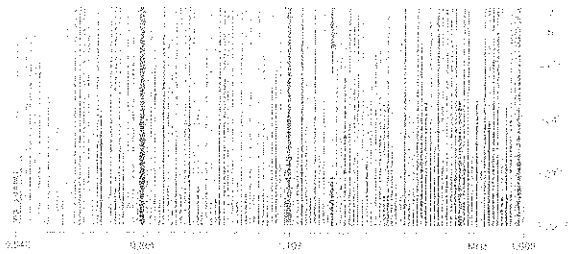

Fig. 12 Frequency-band occupancy over medium-wave band plotted on Radiomonitoring Recorder ZSG 3.



Fig. 14 Automatic plotting of field-strength fluctuations on YT recorder at a constant frequency (6.075 MHz); the scale of the Y axis is determined by entering the MAX. and MIN. levels.

• **Programmed frequency scanning** by the ESH 3 reduces the quantity of measured data: only the signal levels above the threshold level and the corresponding frequencies are transferred to the computer.

For all cases where speed is at a premium and the work of the IEC(IEEE)-bus controller is to be minimized the IEC-bus interface of the ESH 3 offers the following possibilities:

The controller instructs each connected ESH 3 to constantly scan a certain frequency range and if the threshold level is exceeded to either

issue a **Service Request** in reply to which the controller identifies the ESH 3 that is calling by way of a **Serial Poll** and accepts the measured data,

or to answer a **Parallel Poll** of the controller.

It therefore depends on the controller capabilities whether or not the ESH 3 can be used to full advantage.

The front panel of the ESH 3 has been laid out with an eye to **logical organization and intelligibility of the controls, displays, and engravings**. All settings are indicated by LEDs.

Operator errors cause the following responses: When an inhibited key is pressed the LED of the function causing the inhibit blinks; when the operating range of the demodulator is exceeded or essential stages are overdriven (cw or by pulses) the data readout blinks; when illegal data are input or an essential module fails, a coded error message appears and an aural signal comes on. The end of measurements that have been carried out over an extended period of time is also signalled aurally.

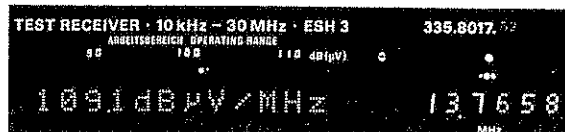

Fig. 15 Front-panel frequency display and alphanumeric display for readout of measured data, input and output of setting data and output of error messages.

The 13-digit alphanumeric display (Fig. 15) on the one hand **outputs the measured data complete with units** and on the other hand permits checking the formatted input of setting data. Since these data cannot all be read out at the same time, they can be called up for indication at the push of a key.

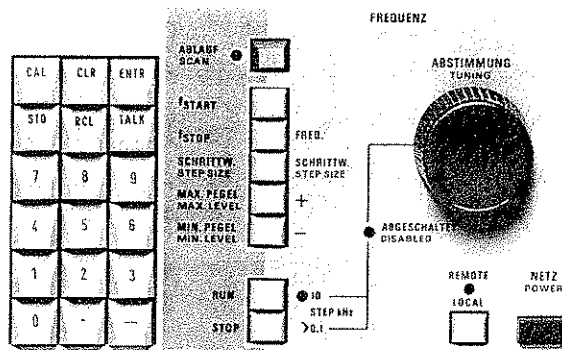

Fig. 16 Front-panel controls for frequency entry and scanning.

The battery-buffered memory of the ESH 3 stores the last and nine more complete device settings. In addition, it stores all correction values for frequency response, IF bandwidths, and demodulator characteristics obtained in an automatic calibration procedure. As a result, full accuracy is ensured at all times and the measuring times in automatic operation are considerably reduced.

Frequency setting is possible in several ways, calibrated offset indication being provided as a tuning aid (Fig. 16):

- quasi-continuous in 100-Hz or 10-kHz (switch-selected) steps by means of a rotary knob;
- in steps of any preset size, e.g. in 9-kHz steps, or in steps of the fundamental frequency for measuring harmonics;

- direct keyboard entry of a numerical value;
- automatic frequency scanning over maximum of five sub-ranges with programmable start and stop frequencies and step sizes.

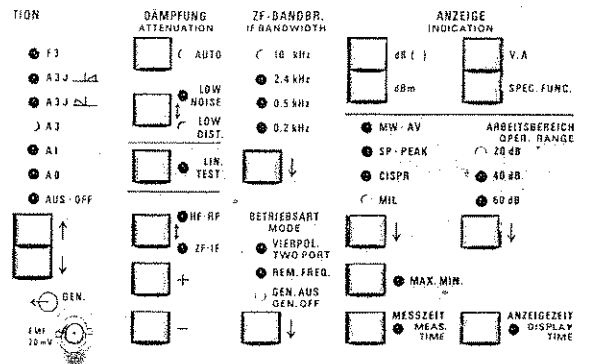

Fig. 17 Front-panel controls for indication, IF bandwidths, modes, attenuation, and demodulation.

Range selection for level measurements can be made either manually by separate setting of the RF and IF attenuation (Fig. 17) or by automatic RF attenuation setting (autoranging) with the low-noise or low-distortion IF attenuation setting determined by the selected IF bandwidth and indicating mode. In addition, a 1-dB RF attenuator is provided for a **linearity test**.

Conversion factors for probes and test antennas. The use of probes and test antennas with the ESH 3 does not cause additional work for the user when making measurements, since the correct units are automatically switched in and the conversion factors for probes and test antennas taken into consideration. Reading errors are thus rare.

Three demodulator operating ranges. Three demodulator operating ranges covering 20, 40 or 60 dB are provided to meet the measurement needs. **Automatic attenuation setting** (autoranging) is effected in 10-, 20- or 30-dB steps depending on the operating range.

Level indication. The operating range also determines the dynamic range of the analog level indication, which consists of an array of 31 LEDs. The range limits of this analog indication and the RF attenuation setting are digitally displayed.

Calibration. By either momentarily pressing the CAL key or holding it down, two different calibration processes can be triggered:

1. Adjustment of IF gain and frequency offset to the nominal value a receiver frequency of 1 MHz and subsequent verification of the level measurement at the original frequency.
2. Measurement and storage in non-volatile memory of all calibration correction values that are constant over a long period of time: frequency response, gain differences with different IF bandwidths and demodulator linearity.

DESCRIPTION

Operating principle. The Test Receiver ESH 3 is a triple heterodyne receiver with the following features:

RF attenuator, switchable in 10-dB steps from 0 to 140 dB; a 1-dB attenuator for linearity tests.

Diode mixer of high linearity following 16 switchable band-pass filters without amplifier to achieve an extremely wide dynamic range.

IF bandwidth, switch-selected: 0.2 kHz, 0.5 kHz, 2.4 kHz and 10 kHz.

Signal evaluation with average- and peak-value indication, pulse weighting to CISPR Publ. 1 and 3.

Measuring times, programmable, 5 ms to 100 s, for ready adaptation to measurement needs.

"MIL" indicating mode, peak-value indication, with IF bandwidth correction values automatically taken into consideration, for measuring broadband interference.

MAX-MIN indicating mode, measurement of range of variation of input signal in a sequence of programmable length, consisting of individual measurements of 100 ms duration each.

Display period, separately programmable; ensuring that signals exceeding a programmed threshold are indicated long enough during automatic frequency scanning.

Mixer oscillators based on synthesizer principle.

Up-conversion 1st IF (75 MHz) with 10-kHz crystal filter – minimizing intermodulation risk and easing the pulse linearity requirements on the succeeding stages.

2nd IF at 9 MHz with crystal filters for 0.5 and 2.4 kHz bandwidth and adjustable gain for calibration purposes.

3rd IF at 30 kHz with **attenuator switchable** in 10-dB steps from 0 to 40 dB and a mechanical 200-Hz filter; linear IF gain for 20-dB operating range and logarithmizing IF amplifier for 40- and 60-dB operating ranges.

Active demodulator with switch-selected CISPR weighting and peak-value measurement; circuits for measuring modulation depth.

Demodulator circuits for FM and A3; BFO for A0, A1 and A3J (upper and lower sideband); automatic IF gain control for all AM demodulators; built-in loudspeaker; FM demodulator also used as signal source for frequency offset and deviation measurements.

Calibration generator with high-stability sinewave source (tracking generator) and pulse generator for CISPR calibrations.

The test voltage is applied via a sample-and-hold circuit to a **10-bit A/D converter** with a conversion time of about 25 μ s. The combination of microprocessor + A/D converter permits 64 measurements in 5 ms, perfect digital averaging being provided even at the maximum IF bandwidth of 10 kHz. Digital averaging does away with the settling time required with analog low-pass filters. Thus autoranging is possible in a minimum of time.

The measured value is converted into a level value, then RF and IF attenuation, all calibration correction values and any conversion factors for probes or test antennas are added before it is read out with the correct units on the alphanumeric display and output to the IEC (IEEE) bus, if required.

Construction. **Modular construction** – almost all modules are exchangeable independent of each other, the RF modules are of modern cassette design – and the signature analysis capability and provision of firmware test routines make the ESH 3 very easy to service. Low internal heating of the receiver reduces the failure rate of component parts.

SPECIFICATIONS

Frequency range 9 kHz to 29.9999 MHz

Frequency setting 1. in 100-Hz or 10-kHz steps (switch-selected) by means of tuning knob
2. keyboard entry of numerical value
3. in steps of any preset size
4. automatic scanning

Readout 6-digit LED display

Resolution 100 Hz

Setting accuracy ¹⁾
from 10 to 150 kHz to within 100 Hz
from 150 kHz to 30 MHz to within 500 Hz

RF input $Z_{in} = 50 \Omega$, BNC female

VSWR < 1.2 with RF attenuation ≥ 10 dB
< 2 with RF attenuation 0 dB

Oscillator reradiation < 0 dB μ V

Input filter

Range 1	9 to < 150 kHz	band-pass filter	
2	150 to < 200 kHz		
3	200 to < 280 kHz		
4	280 to < 390 kHz		
5	390 to < 540 kHz		
6	540 to < 750 kHz		
7	0.75 to < 1.05 MHz		sub-octave filters
8	1.05 to < 1.45 MHz		
9	1.45 to < 2.0 MHz		
10	2.0 to < 2.7 MHz		tracking filters
11	2.7 to < 3.7 MHz		
12	3.7 to < 5.2 MHz		
13	5.2 to < 7.2 MHz		
14	7.2 to < 10 MHz		
15	10 to < 20 MHz		
16	20 to < 30 MHz		

Maximum input level with
RF attenuation 0 dB 130 dB μ V
RF attenuation ≥ 10 dB 137 dB μ V

Maximum pulse energy with
RF attenuation ≥ 20 dB 1 mWs

Interference immunity, non-linearities

Image frequency rejection > 100 dB, typ. 120 dB

IF rejection > 100 dB, typ. 110 dB

Non-linearities: a) frequency range 10 to 150 kHz
(≈ 40 kHz off carrier)
b) frequency range 150 kHz to 30 MHz

Type	Signal level dB μ V	Intermod. ratio dB	Intercept point guaranteed dBm	typical dBm
a) k_2	100	> 55	+ 30	+ 45
d_2	100	> 50	+ 25	+ 40
d_3	90	> 65	+ 15	+ 20
b) k_2	100	> 80	+ 75	+ 100
d_2	100	> 60	+ 55	+ 75
d_3	100	> 52	+ 20	+ 25

Crossmodulation
An interference signal of $m = 30\%$ and $f = 1$ kHz spaced > 100 kHz away produces 3% spurious modulation of 20-dB μ V signal at a level of > 100 dB μ V

RF leakage
Difference in reading with field strength $10 V/m$ ($f \neq f_{in}$) < 1 dB

Radio interference (EMI) from
internal microcomputer, etc. below VDE 0876 tolerance limits

Intermediate frequencies

1st IF 75 MHz
2nd IF 9 MHz
3rd IF 30 kHz

IF bandwidths (average and peak value)

Nominal bandwidth	3-dB bandwidth	6-dB bandwidth	6:60 dB ratio
200 Hz ²⁾	160 Hz ³⁾	200 Hz	approx. 1:5
500 Hz	550 Hz ³⁾	630 Hz	approx. 1:5
2.4 kHz	2.4 kHz	2.6 kHz	approx. 1:1.8
10 kHz	8 kHz ³⁾	9.5 kHz	approx. 1:2.4

IF bandwidth (-6 dB) for measurements to CISPR (Publ. 1 and 3) and VDE 0875 0.2 kHz/9 kHz (automatically switched over)

Internal noise a ($f_{in} > 50$ kHz)

Average value $B = 200$ Hz typ. -30 dB μ V
Peak value $B = 200$ Hz typ. -22 dB μ V
CISPR 1 $B = 9$ kHz typ. -6 dB μ V
CISPR 3 $B = 200$ Hz typ. -28 dB μ V

Pulse spectral density (MIL) $B = 10$ kHz typ. 38 dB(μ V/MHz)

Increase in internal noise see diagram ($f_{in} < 50$ kHz, $B = 200$ Hz)

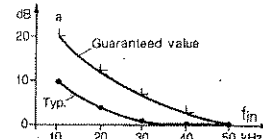

Measurement ranges

Lower limit
(3 dB above noise level) see noise indication
Upper limit + 137 dB μ V
Inherent spurious responses equivalent to < -6 dB μ V

Indication
digital in dB μ V, dBm 4 digits, max.; resolution 0.1 dB
in μ V, mV, V 3 digits
analog LED array (31 LEDs) over operating range of IF rectifier with digital indication of range limits

Operating ranges of
IF rectifier 20, 40, 60 dB

Indication of measured data
Indicating modes average value (programmable averaging time)
peak value (programmable hold time)
pulse spectral density to MIL (programmable hold time)
CISPR Publ. 1 and 3 (programmable measuring time)
Programmable measuring times: 5 ms to 100 s
Measurement of maximum and minimum levels: the maximum and minimum levels are determined from individual measurements of 0.1 s duration each; programmable measuring time: 1 to 1000 s

Measuring error
Error of level indication for unmodulated sinewave signals ≈ 16 dB above the indicated noise level (AV) < 1 dB
Additional error over operating ranges 40 and 60 dB typ. < 0.5 dB

Level calibration
Average/peak value tracking generator (sinewave)
CISPR pulse generator

Error of analog level indication
Operating range 20 dB typ. < 2 dB
Operating ranges 40, 60 dB typ. < 4 dB

Frequency offset
Indication
digital in kHz 3 digits, resolution 0.01 kHz
analog LED array (16 LEDs)
Measurement range ($B = 10$ kHz) -5 to +5 kHz

Measuring error
Centre frequency (calibrated) < 0.1 kHz (without frequency setting error)
Offset from centre frequency < 10%

Frequency deviation
(positive and negative peak deviation and average deviation)
Digital indication in kHz 3 digits, resolution 0.01 kHz
Measurement range 0.05 to 5 kHz
(deviation + $f_{mod} \leq B_{IF} \cdot 3 \text{ dB}/2$)
Measuring error at S/N ratio > 40 dB < 10%

Modulation depth
(positive and negative peak value and average AM)
Digital indication in % 2 digits, resolution 1%
Measurement range about 2 to 99%
Measuring error (IF attenuation = 40 dB and analog level indication in upper half of 20-dB operating range), $f_{mod} \approx 1$ kHz at $B_{IF} = 10$ kHz < 5 digits

¹⁾ For greater setting accuracies, the ESH 3 has an input for an external reference frequency of 5 or 10 MHz.

²⁾ The accuracy is reduced when measuring sinewave signals at 200 Hz bandwidth (additional measuring error 1.5 dB) because the receiver is tuned in 100-Hz steps.

³⁾ $\pm 20\%$.

SPECIFICATIONS

Gain	
Digital Indication in dB	4 digits, max.; resolution 0.1 dB
Measurement range	(-110) - 100 to +57 dB
Absolute error	< 1 dB, typ. < 0.5 dB
Demodulation modes	A0, A1, A3, A3J, (LSB/USB), F3
Remote control	
Interface to IEC 625-1 (IEEE 488)	for controlling all device functions and for data output
Interface functions	AH1, L4, SH1, T5 SR1, PP1, DC1, DT1, RL1, CØ
Typical data rate in	
Talker Mode	approx. 5 kbyte/s
Listener Mode	approx. 2 kbyte/s
Setting times	
Internal frequency	
In steps of 0.1 to 99 kHz	typ. 10 ms to 20 ms
when exceeding a 100-kHz digit	typ. 40 ms
RF level switch, internal	30 ms/step
Max. measuring time with R&S Process Controller PPC, frequency step size ≤ 1 kHz, measuring time set on ESH 3	5 ms
5 ms	65 ms/measured value
Connector for remote control	24-way Amphenol female

Front panel outputs	
Generator output (can be switched off)	$Z_{out} = 50 \Omega$, BNC female
EMF	86 dB μ V \pm 0.5 dB
Connector for antenna supply and coding AF output	12-way Tuchel female
AF output	$Z_{out} = 10 \Omega$, telephone Jack JK 34
EMF	adjustable up to 3.5 V

Rear-panel outputs	
IF output 75 MHz	$Z_{out} = 50 \Omega$, BNC female
EMF	about 12 dB above input level with 0 dB RF attenuation corresponds to RF bandwidth
Bandwidth	
IF output 30 kHz	$Z_{out} = 1 k\Omega$, BNC female
EMF	0 to 2 V over range of analog level indication corresponds to IF bandwidth
Bandwidth	
AM demodulator	$Z_{out} = 10 k\Omega$, BNC female
EMF	1 V with $m = 100\%$
FM demodulator	$Z_{out} = 10 k\Omega$, BNC female
EMF	± 0.5 V with deviation = 5 kHz
Frequency offset	$Z_{out} = 10 k\Omega$, BNC female
EMF	± 5 V with offset = 5 kHz
Analog level output 1	$Z_{out} = 10 k\Omega$, BNC female
EMF (with AV, PEAK and MIL indicating mode)	0.5 to 5 V over range of analog level indication
EMF (with CISPR indicating mode)	0.2 to 2 V over range of analog level indication
Analog level output 2	$Z_{out} = 10 k\Omega$, BNC female
EMF (with CISPR indicating mode)	0.2 to 2 V over range of analog level indication (network for simulation of meter response with time constant to CISPR Publ. 1 and 3 provided)

Recorder output	24-way Amphenol female including coding inputs for recorder type D/A converted X and Y analog outputs X = 0 V: start frequency = +10 V: stop frequency Y = 0 V: MIN level = +10 V: MAX level pen lift control, low level corresponding to pen up formatted paper feed for ZSKT (high pulse, duration 10 ms) connection of 5 Radiomonitoring Recorders ZSG 3
-----------------	--

Rear-panel input	
for external reference frequency	$Z_{in} = 50 \Omega$, BNC female
Required level	EMF = 1 V from 50 Ω , sinewave source
Frequency	5/10 MHz (switch-selected)

General Data	
Operating temperature range	+5 to +45 °C
Storage temperature range	-25 to +70 °C ¹⁾
AC supply	115/125/220/235 V +10/-15 %, 47 to 440 Hz (70 VA)
Dimensions; weight	492 mm x 205 mm x 514 mm; 25 kg

Ordering information

Order designation	► Test Receiver ESH 3 335.8017.52
-------------------	--------------------------------------

Accessories supplied	
Power cord	025.2365.00
Manual	

Recommended extras (see also data sheet 303 203)	
For interference measurements:	
Clamp-on RF Current Probe (100 kHz to 30 MHz)	ESH 2-Z1 ... 338.3516.52
Active Probe (9 kHz to 30 MHz, high impedance)	ESH 2-Z2 ... 299.7210.52
Passive Probe (9 kHz to 30 MHz, VDE 0876)	ESH 2-Z3 ... 299.7810.52
Artificial Mains Network (LISN) (9 kHz to 150 kHz/30 MHz, VDE 0876)	ESH 2-Z5 ... 338.5219.52
Attenuator (20 dB, 10 W)	ESH 2-Z11 ... 349.7518.52
For field-strength measurements:	
Rod Antenna	HFH 2-Z1 ... 335.3215.52
Loop Antenna	HFH 2-Z2 ... 335.4711.52
Loop Antenna	HFH 2-Z3 ... 335.6214.52
Tripod	HFU-Z ... 100.1114.02
Inductive Probe	HFH 2-Z4 ... 338.3016.52
Auxiliary equipment:	
Headphones	110.2959.00
Service Kit	ESH 2-Z7 ... 338.4112.02
XYT Recorder	ZSKT ... 301.9010.02
Connecting Cable	
ESH 3 - ZSKT (XY)	ESH 3-Z1 ... 349.6011.02
Radiomonitoring Recorder	ZSG 3 ... 242.6015.92
Universal Printer	PUD ... 349.5914.02
IEC (IEEE) Interface Option	PUD-B4 ... 349.9404.02

Frequency counter for remote frequency measurements, sensitivity better than 10 mV into 50 Ω , such as PM6615/04 from Philips
Sinewave inverter for operating the ESH 3 from a 12-V battery, such as SWR 200 from Audioteknik, Bad Salzflun

¹⁾ The receiver uses a NiCd storage battery for buffer operation of the CMOS RAMs. It should, therefore, not be stored at ambient temperatures above +50 °C over an extended period of time.



ROHDE & SCHWARZ

GmbH & Co. KG · D-8000 München 80 · Mühldorfstr. 15 · Tel. (089) 41 29-1 Int. + 49 89 41 29-1 · Telex 5 23 703
Printed in the Fed. Rep. of Germany · Subject to change · Data without tolerances: order of magnitude only

1081 (Bv)

Table of Contents

<u>1.</u>	<u>Data Sheet</u>	
	Special Features	
	Specifications	
	General Data	
	Recommended Extras	
<u>2.</u>	<u>Preparation for Use and Operating Instructions</u>	<u>2.1</u>
2.1	Legend for the Front- and Rear-panel Views	2.1
2.2	Preparation for Use	2.11
2.2.1	Setting Up the Receiver	2.11
2.2.1.1	Operating Position and Ambient Light	2.11
2.2.1.2	Temperature and Condensed Moisture	2.11
2.2.1.3	Vibration and Low-frequency Magnetic Fields	2.12
2.2.1.4	RF Fields	2.12
2.2.1.5	Earth Connections	2.12
2.2.1.6	Mounting the Receiver in a Rack	2.12
2.2.2	Power Supply	2.13
2.2.2.1	AC Supply Operation	2.13
2.2.2.2	Battery Operation	2.13
2.2.3	Switching on	2.13
2.2.4	Functional Check	2.14
2.3	Operating Instructions	2.15
2.3.1	Connection of the Voltage to be Measured	2.15
2.3.1.1	Sinewave Signals and DC Voltage	2.15
2.3.1.2	Pulse Signals	2.15
2.3.2	Frequency Setting	2.16
2.3.2.1	Automatic Frequency Scanning	2.16
2.3.3	Selection of IF Bandwidth	2.17
2.3.4	Selection of Indicating Mode	2.18
2.3.5	Selection of the Operating Level Range	2.22

2.3.6	Setting of Attenuation and Measurement Ranges	2.23
2.3.6.1	Manual Setting	2.23
2.3.6.2	Automatic Setting (Autoranging)	2.24
2.3.7	Calibration	2.26
2.3.8	Setting the Data Output	2.26
2.3.9	Setting the Measuring Time	2.29
2.3.10	Setting the Display Time	2.29
2.3.11	Selection of Demodulation Modes	2.30
2.3.12	Operating Modes TWOPORT and REM. FREQ. 38	2.30
2.3.13	Special Functions	2.31
2.3.14	Storage and Recalling of Control Settings	2.34
2.3.15	Connection of Test Antennas and Probes	2.34
2.3.16	Data Output on a Listen Only Recording Device (Printer, Magnetic Tape Memory, etc.)	2.36
2.3.17	IF, AF and Recorder Outputs	2.37
2.3.18	Operation of the ESH 3 Using an External Reference Frequency	2.37
2.3.19	Connection of Recorders to the Output <u>58</u>	2.37
2.3.19.1	Wiring Scheme for Connecting Cables	2.40
2.3.19.2	Setting the ESH 3 for Output to a Recorder	2.42
2.3.19.2.1	YT Recorder (Y = level; T = automatic time base)	2.42
2.3.19.2.2.	XY Recorder (Y = level; X = frequency)	2.42
2.3.19.2.3	Radio Monitoring Recorder ZSG 3	2.43
2.3.20	Error Messages	2.43
2.3.21	Control of the ESH 3 via IEC Bus	2.45
2.3.21.1	Setting the Device Address/Talk Only Mode	2.46
2.3.21.2	Interface Functions	2.46
2.3.21.3	Setting Instructions	2.47
2.3.21.3.1	Data Entry	2.49
2.3.21.4	Data Output	2.52
2.3.21.5	Group of Addressed and Universal Commands	2.54
2.3.21.5.1	Remote/Local	2.54
2.3.21.5.2	Device Clear	2.54
2.3.21.5.3	Device Trigger	2.54
2.3.21.6	"Service Request" and "Parallel Poll"	2.56







2.4	Examples of Measurements	2.61
2.4.1	Measurement of Sinewave Signals	2.61
2.4.1.1	Measurement Accuracy (Noise Effects)	2.61
2.4.1.2	Influence of Amplitude Modulation	2.65
2.4.1.3	Measurement of Frequency Offset and Deviation	2.67
2.4.1.4	Measurement of Modulation Depth	2.67
2.4.2	Measurement of Pulse Signals and Broadband Noise	2.67
2.4.2.1	Interference Measurement According to VDE and CISPR	2.68
2.4.2.2	Measurement of Broadband Interference in Accordance with MIL Standards and VG Regulations	2.69
2.4.3	Measurement of Varying Signals with the Indicating Mode MAX.MIN	2.69
2.4.4	Twoport and Reflection-coefficient Measurement	2.70
2.4.5	Remote Frequency Measurement	2.71
2.4.6	Measurement of Harmonics, Non-harmonic Spurious Signals, and Sideband Noise	2.72
2.4.6.1	Measurement of Harmonics	2.72
2.4.6.2	Measurement of Non-harmonic Spurious Signals	2.72
2.4.6.3	Measurement of Sideband Noise	2.72
2.4.7	Linearity Measurements on Amplifiers and Tuners (Compression, Intermodulation, Cross Modulation)	2.73
2.4.8	Recording of Signals	2.73
2.4.8.1	Recording of Signal Level and Frequency Offset as a Function of Time	2.74
2.4.8.2	Recording of Signal Level as a Function of Frequency	2.75
2.4.8.2.1	Output to an XY Recorder Via <u>58</u> with Automatic Frequency Scanning	2.75
2.4.8.2.2	Output to a Printer Via <u>57</u>	2.75
2.4.8.3	Recording of Frequency Band Occupancy as a Function of Time	2.75

2. Preparation for Use and Operating Instructions

(See Figs. 2.13 and 2.14 in the appendix)

The values specified in this section are not guaranteed. Only the specifications given in the data sheet are binding.

2.1 Legend for the Front- and Rear-panel Views

Ref. No.	Labelling	Function
<u>1</u>	NF AF	AF output socket with switching contact for <u>3</u> . $Z_{out} = 10 \Omega$; $P_{out max} = 0.4 W$.
<u>2</u>		Volume control for <u>1</u> and <u>3</u> .
<u>3</u>		Built-in loudspeaker, which is switched off when a phone jack PL 55 is inserted into <u>1</u> .
<u>4</u>	DEMODULATION F3 A3J  A3J  A3 A1 A0 AUS . OFF  	LEDs for indication of the selected form of AF demodulation. - for frequency-modulated signals - for SSB signals (USB) - for SSB signals (LSB) - for amplitude-modulated signals - for telegraphy reception - for frequency tuning to zero beat - AF amplifier switched off. Keys for selection of AF demodulation: - selects next function up - selects next function down
<u>5</u>	ZF-BANDER. IF BANDWIDTH 10 kHz 2.4 kHz 0.5 kHz 0.2 kHz 	Key for selection of IF bandwidth. The selected bandwidth is indicated by means of a LED. If the indicating mode selector <u>35</u> is on CISPR, 0.2 kHz is always selected for CISPR 3, and 10 kHz for CISPR 1. If the demodulation mode selector <u>4</u> is on A3J, a bandwidth of 2.4 kHz is always selected.

Ref. No.	Labelling	Function
<u>6</u>	BUSY	LED for indication of extended measuring and calibration processes and internally-controlled frequency scanning.
<u>7</u>	ÜBERSTEUERT OVERDRIVEN	LED for indication of overload a) when one of the overload detection circuits in the 1st, 2nd or 3rd mixer responds; b) when non-linearity is detected by means of LIN. TEST <u>39</u> and AUTO <u>43</u> .
<u>8</u>	HF-DÄMPFUNG dB RF ATTENUATION	3-digit 7-segment display of RF attenuation selected.
<u>9</u>	dB(...)	Key for the selection of the physical unit - dB (μ V), etc. - for the RF input level readout. For details see section 2.3.8.
<u>10</u>	dEm	Key to select dEm as the physical unit for the RF input level readout (only if AV. and PEAK are selected at <u>35</u> , but <u>not</u> if an antenna, probe, etc. is connected to <u>48</u> and the TWOPORT mode is selected at <u>38</u>).
<u>11</u>	SPEC. FUNC.	Key for entering, and then calling up, special functions, such as modulation-depth measurement, frequency-offset and frequency-deviation measurement, in conjunction with keyboard <u>32</u> . For the codes for the various settings, see section 2.3.13.
<u>12</u>	V, A	Key for selection of the physical unit (μ V, mV, V, etc.) for the RF input level readout. For details see section 2.3.8.
<u>13</u>		13-digit alphanumeric LED display for readout of measured data, input and output of setting data and output of error messages.

Ref. No.	Labelling	Function
		Display flashes if the operating range is exceeded at either end or in the case of overload.
<u>14</u>	ARBEITSBEREICH OPERATING RANGE dB (uV)	Analog level indication over selected operating range. LED array consisting of 31 LEDs, with one individual LED each for indication if the operating range is exceeded at either limit, and three 3-digit 7-segment displays marking the beginning, centre and end of the selected demodulator operating range. The LED row displays the voltage level at input <u>45</u> in dB (uV) over all the operating ranges selected by means of <u>33</u> .
<u>15</u>	CAL.	Key which initiates calibration processes: - pressed momentarily (< 3 s): testing and, if necessary, correction of level and frequency offset calibration; - held down (> 3 s): measuring and storing the RF frequency response, IF bandwidth corrective values and demodulator characteristics. During the calibration processes the LED BUSY <u>6</u> is on. For details see section 2.3.7.
<u>16</u>	STO RCL	Keys for storing (STO) and recalling (RCL) complete device settings. STO 1 to 5 and RCL 1 to 5 cover the device settings and data for automatic frequency scanning. STO 6 to 9 and RCL 6 to 9 cover only device settings (no frequency scanning). STO \emptyset is not possible; RCL \emptyset selects the basic setting of the receiver. For details see section 2.3.14.
<u>17</u>	CLR	Key for clearing the last numerical entry via <u>32</u> .





Ref. No.	Labelling	Function
<u>18</u>	ENTR	Key for issuing a transfer command after completion of the data entry (key functions <u>26</u> , <u>27</u> , <u>29</u> , <u>30</u> , <u>31</u> , <u>34</u> , <u>37</u> engraved in red).
<u>19</u>	TALK	Key to initiate data output on a printer if the automatic frequency scanning mode of the ESH 3 is not switched on. The printer must be set to LISTEN ONLY. It is connected to the IEC-bus output <u>57</u> . The ESH 3 must be set to TALK ONLY by means of <u>56</u> .
<u>20</u>	MHz	6-digit display of current receiver frequency.
<u>21</u>		Analog display of frequency offset of sinusoidal input signal, which lies in the IF passband, from the receiver centre frequency. LED array consisting of 16 LEDs plus a LED for indication of centre frequency tuning (positive offset: indication to left of centre). The centre of this analog display is calibrated as part of the automatic calibration process initiated by <u>15</u> .
<u>22</u>	ABSTIMMUNG TUNING ABGESCHALTET DISABLED	Knob for quasi-continuous setting of receiver frequency in 10- and 0.1-kHz steps. This knob is disabled if the LED DISABLED lights (disabled by means of the keys <u>28</u> and <u>25</u> and in remote operation: LED <u>24</u> lights up).
<u>23</u>	NETZ POWER	Power switch.
<u>24</u>	REMOTE LOCAL	The LED REMOTE is lit all the while the ESH 3 is remote-controlled via the IEC-bus connector <u>57</u> . The REN line is in the REMOTE state. Unless a Local Lockout command has been issued the REMOTE state can be interrupted during the program by pressing the LOCAL key. The next addressing operation by the IEC-bus controller restores the REMOTE state.







Ref. No.	Labelling	Function
<u>25</u>	ABLAUF SCAN	On/off key for automatic scanning. The LED lights up to indicate that the engravings on the left-hand side (dark background) apply to the entire row of keys <u>26</u> , <u>27</u> , <u>28</u> , <u>29</u> , <u>30</u> and <u>31</u> .
<u>26</u>	MAX. PEGEL + MAX. LEVEL	Key with two functions: a) LED <u>25</u> SCAN is not on. The receiver frequency is increased at each push of the key by the amount selected with key <u>29</u> . If the key is held down the key function is repeated automatically. b) LED <u>25</u> SCAN is on. The upper level limit for automatic scanning which is essential for setting the output to an XY recorder can be called up and entered (see section 2.3.19). For data transfer, key <u>18</u> ENTR is pressed.
<u>27</u>	MIN. PEGEL - MIN. LEVEL	Key with two functions: a) LED <u>25</u> SCAN is not on. The receiver frequency is decreased at each push of the key by the amount fixed with key <u>29</u> . If the key is held down the key function is repeated automatically. b) LED <u>25</u> SCAN is on. The lower level limit essential for the detection of signals and for setting the output to an XY recorder when using automatic scanning can be called up and entered (see sections 2.3.16 and 19). For data transfer, key <u>18</u> ENTR is pressed.
<u>28</u>	RUN 10 STEP kHz STOP 0.1	Keys with two functions and two LEDs: a) LED <u>25</u> SCAN is not on. The keys are used for selection of the step size of the pulse from the pulse generator <u>22</u> . If the same key is pressed again the pulse generator <u>22</u> is switched off. b) LED <u>25</u> SCAN is on. By pressing the RUN key frequency scanning, in accordance with the current data setting, is initiated.

Ref. No.	Labelling	Function												
		<p>A figure F (1 to 5) + RUN initiates scanning according to the data stored via STO F. Several figures + RUN initiate scanning of several subranges. At a single push of the STOP key frequency scanning is stopped. Data settings can be changed and scanning can be continued by pressing the RUN key again. If the STOP key is pressed again, frequency scanning is discontinued. If the RUN key is pressed again, scanning is resumed at the start frequency.</p>												
<u>29</u>	<p>SCHRITTW. SCHRITTW. STEP SIZE STEP SIZE</p>	<p>Key with two functions:</p> <p>a) LED <u>25</u> SCAN is not on. By pressing this key the step size of the frequency variation (by means of <u>26</u> and <u>27</u>) is called up and keyed in. For data transfer, key <u>18</u> ENTR is pressed.</p> <p>b) LED <u>25</u> SCAN is lit. By pressing this key the step size in automatic scanning can be called up and entered. For data transfer, key <u>18</u> ENTR is pressed.</p>												
<u>30</u>	<p>f_{STOP} FREQ.</p>	<p>Key with two functions:</p> <p>a) LED <u>25</u> SCAN is not on. By pressing this key the receiver frequency can be keyed in via the numerical keyboard. For data transfer press key <u>18</u> ENTR.</p> <p>b) LED <u>25</u> SCAN is on. By pressing this key the stop frequency of the automatic scan can be called up and entered. For data transfer, key <u>18</u> ENTR is pressed.</p>												
<u>31</u>	<p>f_{START}</p>	<p>a) LED <u>25</u> SCAN is not on - no function. b) LED <u>25</u> SCAN is on. By pressing this key the start frequency of the automatic scan can be called up and entered. For data transfer <u>18</u> ENTR is pressed.</p>												
<u>32</u>	<table border="0"> <tr><td>7</td><td>8</td><td>9</td></tr> <tr><td>4</td><td>5</td><td>6</td></tr> <tr><td>1</td><td>2</td><td>3</td></tr> <tr><td>∅</td><td>.</td><td>-</td></tr> </table>	7	8	9	4	5	6	1	2	3	∅	.	-	<p>Keyboard for entry of numerical values for the functions of: <u>11</u>, <u>16</u>, <u>26</u>, <u>27</u>, <u>29</u>, <u>30</u>, <u>31</u>, <u>34</u>, <u>37</u>.</p>
7	8	9												
4	5	6												
1	2	3												
∅	.	-												

Ref. No.	Labelling	Function
<u>33</u>	ARBEITSBEREICH OPEP. RANGE 20 dB 40 dB ↓ 60 dB	LEDs plus selector switch for the operating range of the analog indication <u>14</u> . The steps of automatic attenuation setting by means of <u>43</u> are set together with the operating range (see section 2.3.6).
<u>34</u>	ANZEIGENZEIT DISPLAY TIME	Key for calling up and entering the time the measured data is displayed on <u>13</u> . If the display time is different from the measuring time the associated LED lights up. The display time is always greater or equal to the measuring time set using <u>37</u> .
<u>35</u>	RW AV SP PEAK CISPR MIL ↓	LEDs plus selector switch for the indicating modes: average value, peak value, interference measurement according to CISPR, broadband interference measurement according to MIL standards. In the MIL indicating mode the peak value in dB ($\mu\text{V}/\text{MHz}$) is read out.
<u>36</u>	MAX. MIN.	On/off switch for special indicating mode MAX. MIN. which permits the range of variation of the RF input level to be determined. Maximum and minimum are determined from individual measurements within the measuring time fixed by means of <u>37</u> , and indicated side by side. The individual measurements are carried out in accordance with the mode of demodulation selected by means of <u>35</u> . For details see section 2.3.10.
<u>37</u>	MESSZEIT MEAS. TIME	Key for calling up and entering the measuring time = time of average- or peak-value measurement with steady-state rectified voltage at the A/D converter input. LED is on: difference from basic setting. For details see section 2.3.9.
<u>38</u>	BEFRIEDSART NODE VIERPOL. TWO-PORT	LEDs plus selector switch for the operating mode of the BSH 3: a) Gain measurement on twoport networks (-110 to +57 dB). The generator output <u>44</u> (BHP: 86 dB (μV),

Ref. No.	Labelling	Function
	REM. FREQ. GEN. AUS GEN. OFF ↓	<p>f = receiver centre frequency) is switched on.</p> <p>b) Remote frequency measurement. The ESH 3 operates as a tunable, active filter. The generator output <u>44</u> delivers the RF input signal which is filtered according to the selected IF bandwidth and has an EMF of 86 dB (µV) for connection of a frequency counter. The receiver functions as in the GEN. OFF mode.</p> <p>c) The generator output <u>44</u> is switched off.</p>
<u>39</u>	LIN. TEST	<p>On/off switch for linearity test.</p> <p>To check the linearity of the RF and IF stages of the ESH 3 the RF attenuation is increased by 1 dB (with average- and peak -value indication) or 10 dB (with CISPR and MIL indication). The actual RF attenuation is always read out on display <u>8</u>. LED <u>39</u> lights up if the RF attenuation is increased. If automatic attenuation setting is selected by means of <u>43</u> the difference is automatically indicated after two consecutive measurements. If manual RF and IF setting is selected by means of <u>40</u> only the result is indicated. The additional attenuation can be switched off or on by pressing key <u>39</u>.</p>
<u>40</u>	↑ HF · RF ↓ ZF · IF	<p>Key with two functions for manual setting of the RF and IF attenuation.</p> <p>a) Switches over from automatic attenuation setting mode <u>43</u> to manual RF attenuation.</p> <p>b) Switches over from manual RF to manual IF attenuation setting mode and vice versa. The LEDs indicate whether the RF or IF attenuation can be varied by means of <u>41</u>. The RF attenuation is read out on display <u>8</u>. The IF attenuation can be selected in accordance with section 2.3.6.</p>

Ref. No.	Labelling	Function
<u>41</u>	+ -	Keys for manual increase (+) and decrease (-) of RF or IF attenuation selected by means of <u>40</u> . If the key is held down the keying is repeated automatically.
<u>42</u>	LOW NOISE ↕ LOW DIST.	Selector switch for low-noise or low-distortion measurement. For low-distortion measurement the IF attenuator setting is always 10 dB less. For details see section 2.3.6.
<u>43</u>	AUTO	Key for switching over from manual to automatic RF attenuator setting with low-noise or low-distortion IF attenuation setting depending on <u>42</u> .
<u>44</u>	 GEN EMF 20 mV	Generator output (BNC socket) for twoport or remote-frequency measurement. The function depends on the mode of operation selected by means of <u>38</u> .
<u>45</u>	 HF . RF 50 Ω < 3 V	RF input socket (BNC). Do not exceed maximum input voltage stated in section 2.3.1.
<u>46</u>		Socket (4 mm diameter) for earth connection.
<u>47</u>	ANTENNA CODE	12-pole supply and coding socket for connection of active or passive test antennas/probes. Outputs: +10 V, -10 V (max. 50 mA). Coding input to set conversion factor and quantity to be measured (see section 2.3.15).
<u>48</u>	 ZF/IF 30 kHz	BNC output socket for the 3rd IF of 30 kHz. EMF at maximum analog reading: approx. 2 V; $Z_{out} = 1 \text{ k}\Omega$.
<u>49</u>	 75 MHz ZF/IF	BNC output socket for the 1st IF of 75 MHz. Gain relative to RF input with 0 dB RF attenuation: $9 \pm 3 \text{ dB}$; $Z_{out} = 50 \Omega$.

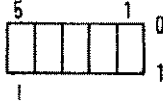
Ref. No.	Labelling	Function
<u>50</u>	 AM	BNC output socket for the demodulated AM signal. EMF at 100% modulation depth: 1 V; $Z_{out} = 10 \text{ k}\Omega$.
<u>51</u>	 FM	BNC output socket for the demodulated FM signal. EMF at ± 5 kHz frequency deviation: ± 0.5 V; $Z_{out} = 10 \text{ k}\Omega$.
<u>52</u>	CISPR 	BNC output socket for level recording voltage weighted in accordance with CISPR; output circuit includes a low-pass filter for simulation of panel-meter response. EMF at maximum analog reading: approx. 2 V; $Z_{out} = 10 \text{ k}\Omega$.
<u>53</u>	MW/SP AV/PK 	BNC output socket for level recording voltage in the indicating modes AV., PEAK and MIL. EMF at maximum analog reading: approx. 5 V; $Z_{out} = 10 \text{ k}\Omega$.
<u>54</u>	FREQ. DEV. 	BNC output socket for frequency offset recording voltage. EMF at ± 5 kHz frequency offset: ± 5 V; $Z_{out} = 10 \text{ k}\Omega$.
<u>55</u>	INT 10 MHz EXT 5 MHz  EXT. REF.	BNC input socket for external reference frequency of 5 or 10 MHz. Dual switch for Internal reference: Left-hand switch up External reference: 5 MHz: left-hand switch down right-hand switch down 10 MHz: left-hand switch down right-hand switch up
<u>56</u>	ADDRESS  TALK ONLY	Address selector switch for remote control of the ESH 3 in accordance with IEC 625 (IEEE 488) a) TALK ONLY switch in position 0: the ESH 3 can be remotely operated via a bus controller. b) TALK ONLY switch in position 1: the ESH 3 can send data to a Listen Only device.

Ref. No.	Labelling	Function
<u>57</u>	IEC 625 EUS	24-way socket for remote control of the ESH 3 in accordance with IEC 625 (IEEE 488). See section 2.3.21.
<u>58</u>	XY RECORDER	24-way socket for controlling XY or YT recorders or up to five Radiomonitoring Recorders ZSG 3. See section 2.3.19.
<u>59</u>	220 V~ T1B 235 V~ 115 V~ T2D 125 V~	Voltage selector and fuse holder containing spare fuses.
<u>60</u>	47...420 Hz	AC supply receptacle.

2.2 Preparation for Use

2.2.1 Setting up the Receiver

The following sections describe the environmental conditions required or to be avoided.

2.2.1.1 Operating Position and Ambient Light

The normal operating position of the ESH 3 is horizontal. When using the receiver in the laboratory it is advisable to set it up on the legs provided on its bottom cover, for easy operation on the work bench and reading convenience. Operation in any other position, however, does not affect its performance. Bright ambient light, in particular sunlight naturally makes reading the LED displays on the front panel more difficult. The front panel should therefore be screened off from bright ambient light.

2.2.1.2 Temperature and Condensed Moisture

The ESH 3 complies with the provisions of the IEC 359 safety class I regulations. The temperature range within which the performance specifications of the ESH 3 are valid is +5 to +45 °C. The receiver - despite its complexity - is a low-power design so that special cooling measures were not called for. Nevertheless, adequate convection of the surrounding air should be ensured, above all when mounting the receiver in a rack. Also, the receiver should not be continually

exposed to bright sunlight. Higher temperatures increase the failure rate of the component parts and the self-discharge of the NiCd battery which is essential for the data storage in the CMOS RAMs. Since the ESH 3 contains high-impedance circuits condensation should be avoided during its operation. Since this is not always possible, in particular when a cold receiver is moved to a warm room with a high relative humidity, some time should be allowed for before switching it on after condensed moisture has collected.

2.2.1.3 Vibration and Low-frequency Magnetic Fields

The ESH 3 contains several varactor-tuned phase-locked oscillators. Strong magnetic fields and heavy vibration may cause the sideband noise of these oscillators to worsen. If exposed to vibration over extensive periods of time the failure rate of the receiver may go up considerably. Receivers used permanently or frequently in vehicles or on planes should therefore be set up with shock absorbers to minimize vibration.

2.2.1.4 RF Fields

Thanks to the excellent screening of the receiver, RF fields up to 10 V/m have no effect. It should, however, be borne in mind that the wideband active test antennas start to overload just above this field strength.

2.2.1.5 Earth Connection

For normal requirements, earth connection via the non-fused earthed conductor of the AC supply receptacle 60 (Fig. 2-12) is sufficient. In some instances, an additional good conductor between the ground and the earth socket 46 may make a noticeable improvement in the earthing.

2.2.1.6 Mounting the Receiver in a Rack

The ESH 3 can be mounted in a 19" rack. To do so, the cover panels of the receiver must be unscrewed, which is best done in the following order:

- Unscrew the upper and the lower cover of the cabinet.
- Remove the side strips (with the recessed grips) from the front and the rear panel.
- Unscrew the aluminium sections on the left- and the right-hand side of the rear panel.

The front-panel screws for fixing the side strips can then be used for screwing the ESH 3 into the rack.

2.2.2 Power Supply

2.2.2.1 AC Supply Operation

The ESH 3 complies with the safety regulations, in accordance with safety class I of VDE 411. Safety class I defines that the AC supply circuits must be insulated during operation and all accessible conductive parts of the device which may immediately carry voltage in case of a failure must be reliably and permanently connected to each other and to the non-fused earthed conductor. The power plug should, therefore, only be connected to an earthing-contact type power outlet. If a separate earth terminal is provided, it must be permanently connected to a non-fused earthed conductor.

The ESH 3 is designed for operation from AC supply voltages of 115 V, 125 V, 220 V and 235 V. It is adjusted at the factory for operation from 220 V. To adapt it for operation from another AC supply voltage, unscrew the fuse holder from the voltage selector 59 (Fig. 2-12), lift off the cover plate and replace such that the appropriate fuse can be inserted for the desired voltage (marked). The receiver is now ready for operation from the new voltage. The fuses for all the AC supply voltages which can be selected are contained in the voltage selector.

For 115 and 125 V, a fuse type T2D DIN 41571 and for 220 and 235 V, a fuse type T1B DIN 41571 is required.

The connection to the AC supply is made via the AC supply receptacle 60.

AC supply voltage variations of between -15% and +10% of the nominal value do not affect the performance. Wider variations should, however, be prevented, otherwise a transformer or regulator must be connected to the input of the test assembly.

2.2.2.2 Battery Operation

The ESH 3 has no battery input. Battery operation is, therefore, only possible via a sinewave inverter which supplies one of the four voltages for which the ESH 3 is designed. Sinewave inverters are available from various manufacturers. A supplier is named in the Technical Information.

2.2.3 Switching on

After adjusting the receiver to the available AC supply voltage and connecting it to the mains, switch on power switch 23. Upon switch-on, and if the NiCd battery for the built-in CMOS RAM is still charged, the receiver wakes up with the same settings it had before it was switched off, but a minimum RF attenuation of 10 dB is always cut in.

Upon switch-on, the following readouts are obtained on display 13 in the order listed:

- 1st R&S ESH 3
- 2nd VERSION 2.0 (Version of the firmware used)
- 3rd BUS ADDR 17 (IEC-bus address set at switch 56;
in the Talk Only mode, BUS ADDR TON is read out)
- 4th CAL. CHECK (Quick calibration)

The ESH 3 is then ready for operation.

2.2.4 Functional Check

The basic setting of the ESH 3 is obtained by pressing the key RCL (16) and \emptyset (32):

Demodulation <u>4</u>	A3J
Attenuation <u>42</u> , <u>43</u>	AUTO, LOW NOISE
IF bandwidth <u>5</u>	10 kHz
Mode <u>38</u>	GEN. OFF
Readout <u>9</u>	dB (...)
Special function <u>11</u>	(no special function is switched on; see section 2.3.13)
Indicating mode <u>35</u>	AV.
Max. Min. <u>36</u>	Switched off
Meas. time <u>37</u>	0.1 s
Operating range <u>33</u>	60 dB
Display time <u>34</u>	0.1 s
Scan <u>25</u>	Switched off
Frequency	1.0000 MHz (adjustable by means of <u>22</u> in 0.1-kHz steps)

The basic setting can be used instead of IEC-bus instructions (see Table 2-11).

By pressing the key CAL 15 for a short time (≤ 3 s), level and frequency offset measurements are calibrated. Instead of a measured value CAL. CHECK is displayed. The analog level indication (above 13) reaches the right-hand end of the LED row 14 and the offset indication 21 is in the centre of the LED row. The calibration process is terminated in less than a second if it proceeds without finding a fault. If not, an error message is output. By switching the ESH 3 off and back again, it is reset to its uncalibrated state.

By pressing key 15 for a longer time (≥ 3 s), the level measurement over the entire frequency range and all the IF bandwidths and operating ranges 33 are calibrated. This calibration process takes about 30 s. Here too error messages are output in the case of any malfunctions.

For checking the level calibration, the ESH 3 can be switched over to the operating mode TWOPORT 38. A short connecting cable between the generator output GEN. 44 and the RF input 45 introduces an attenuation of < 0.2 dB over the entire frequency range. The indication of small attenuation values may be slightly different from the actual value but the error will generally be less than 0.3 dB.

A thorough performance check can be carried out by reference to section 3.

2.3 Operating Instructions

2.3.1 Connection of the Voltage to be Measured

The RF voltage to be measured is connected to the RF input 45 via a 50- Ω coaxial cable. The input impedance of the receiver is 50 Ω . The ESH 3 permits sinewave and pulse voltages to be measured over the 9 kHz to 30 MHz frequency range. The maximum permissible sum voltage of all the signals applied to the input socket of the receiver in the voltage that will not cause any permanent damage, depends on the RF attenuation, the RF bandwidth and the frequency.

2.3.1.1 Sinewave Signals and DC Voltage

The sum voltage must not exceed 3 V into 50 Ω within the RF bandwidth with an RF attenuation of 0 dB. If the RF attenuation is greater than 10 dB, the broadband sum voltage must not exceed 7 V into 50 Ω . Since no DC voltage isolation is provided at the input to the RF level switch, no DC voltages above 7 V must be applied either.

2.3.1.2 Pulse Signals

The sum voltage must not exceed 3 V into 50 Ω within the RF bandwidth with an RF attenuation of 0 dB. This corresponds to a maximum pulse spectral density of 0.6 V/MHz within the widest RF bandwidth provided (5 MHz). An attenuation of 10 dB can be connected (see section 2.3.6) to prevent the RF attenuation of 0 dB from being switched on by the operation of the autoranging circuit.

The maximum permissible pulse energy is 1 mWs (milliwatt-second) into 50 Ω with an RF attenuation of ≥ 10 dB; i.e. a voltage surge of, say, 100 V must not last any longer than 5 μ s.

If these values are exceeded, the input attenuator, RF filter or the input mixer may be destroyed. To prevent this, use of ESH 2-Z11 and ESH 3-Z2 is recommended.

2.3.2 Frequency Setting

The frequency of the ESH 3 can be set in three different ways, not including automatic scanning:

- By means of the control knob 22 in 10- or 0.1-kHz steps. The step size is fixed by means of the pair of keys 28. By pressing one of the two keys twice, the tuning knob is switched off; the LED DISABLED 22 lights up.
- By pressing the keys + 26 and - 27. At each push of these keys the receiver frequency is increased or decreased, respectively, by the amount fixed by the key STEP SIZE 29. If 26 or 27 is held down the keying is repeated automatically.
- By numeric entry. By pressing the key FREQ. 30 the current frequency is read out on the alphanumeric display 13 in MHz. Now a new frequency can be entered via the keyboard 32.

The recalling of front-panel settings stored by means of the STO key can be considered as a fourth way to set the frequency.

2.3.2.1 Automatic Frequency Scanning

A special feature of the ESH 3 is automatic frequency scanning:

By pressing the key SCAN 25 the engravings to the left of the keys 26 to 31 (darker background) are applicable. Now the start and stop frequencies, as well as the step size, for automatic scanning can be selected. The key MIN. LEVEL 27 determines the lower level limit from which signals are scanned. The key MAX. LEVEL 26 permits calibration of the Y axis for output to an XY recorder. Automatic scanning is triggered by pressing the key RUN 28. To interrupt automatic scanning it is only necessary to press the key STOP 28. The front-panel settings can then be altered. Automatic scanning is continued from where it has been interrupted by pressing the key RUN 28 again. An automatic scanning cycle that has not been completed may cause the ESH 3 to act in an unexpected way. A scanning cycle should, therefore, always be terminated by pressing the key STOP 28 twice, if the results of a current operation are no longer required.

By storing several sets of scanning settings using STO 1 to 5 it is possible to arrange for several automatic scanning processes to follow one another. Start and stop frequencies can be set to overlap; between the individual subranges, ranges can be skipped. When driving Radiomonitoring Recorders type

ZSG 3, the minimum levels (threshold levels) set for the individual subranges may also differ. For starting multiple-range scanning, the figures 1 to 5 for the range settings (storage locations) and the key RUN 28 must be pressed. For details about output to recorders see section 2.3.19.

Frequency steps in a constant ratio (logarithmic) are particularly important for automatic scanning in interference measurements. The special functions 52 LIN STEP and 53 LOG STEP permit individual selection of scanning ranges with frequency steps in a constant number of Hz (linear) or ratio. The special function 53 is used to automatically enter the menu for STEP SIZE in %. For reasons of simplicity, the ESH 3 rounds the values off to steps of 100%, 50%, 25% to 0.01%. The switchover 53 ↔ 52 automatically clears the step size memory.

Special function 91 considerably speeds up automatic frequency scanning. The minimum level controls the RF and IF attenuation such that the IF attenuation corresponds to the LOW NOISE setting and the RF attenuation sets the minimum level to the lower end of the 60-dB operating range which is automatically selected in this case. At each selected frequency, the processor checks after a single conversion whether the minimum level is exceeded. If so, the measuring time set becomes effective and the measured value is output. Only the indicating modes AV., PEAK and MIL are permissible, in the CISPR mode, the PEAK indicating mode is selected.

2.3.3 Selection of the IF Bandwidth

The IF bandwidth 5 is selected according to the modulation bandwidth of the signal to be received:

- 10 kHz for AM broadcast signals
- 2.4 kHz for SSB signals
- 500 and 200 Hz for telegraphy reception, etc.

and the required adjacent-channel suppression. For measuring the carrier of AM signals, the 500-Hz bandwidth, for example, will also do.

The IF bandwidth is predetermined by the following functions:

CISPR with $f_{\text{receiver}} < 150 \text{ kHz}$	$B_{\text{IF}} = 200 \text{ Hz}$
CISPR with $f_{\text{receiver}} \geq 150 \text{ kHz}$	$B_{\text{IF}} = 10 \text{ kHz}$
A3J	$B_{\text{IF}} = 2.4 \text{ kHz}$

These functions automatically - as shown above - select the IF bandwidth. Upon any attempt to change the bandwidth, the LED next to the function that is causing the bandwidth to remain fixed, e.g. the LED "CISPR", flashes for about 3 s.

Use of the 200-Hz bandwidth for measuring sinewave signals may introduce an additional measuring error of < 1.5 dB because of tuning in 100-Hz steps.

The 200-Hz bandwidth is preferable for measuring attenuation > 90 dB on two-ports. But it is also possible to select other bandwidths in order to also be able to measure with shorter measuring times.

The bandwidths of $\underline{5}$ correspond approximately to the 6-dB bandwidths. The exact values and tolerances are specified in the Technical Information. The effective selectivity of the individual filters can be seen from Fig. 2-1 and results from the IF selectivity characteristics of the filters used and from the side-band noise of the oscillators in the receiver. The effective selectivity of the 500-Hz and 200-Hz bandwidths can be enhanced by replacing the 500-Hz filter with a compatible 500-Hz filter of similar design but with a higher skirt selectivity (IN 303.9001). The replacement is very simple.

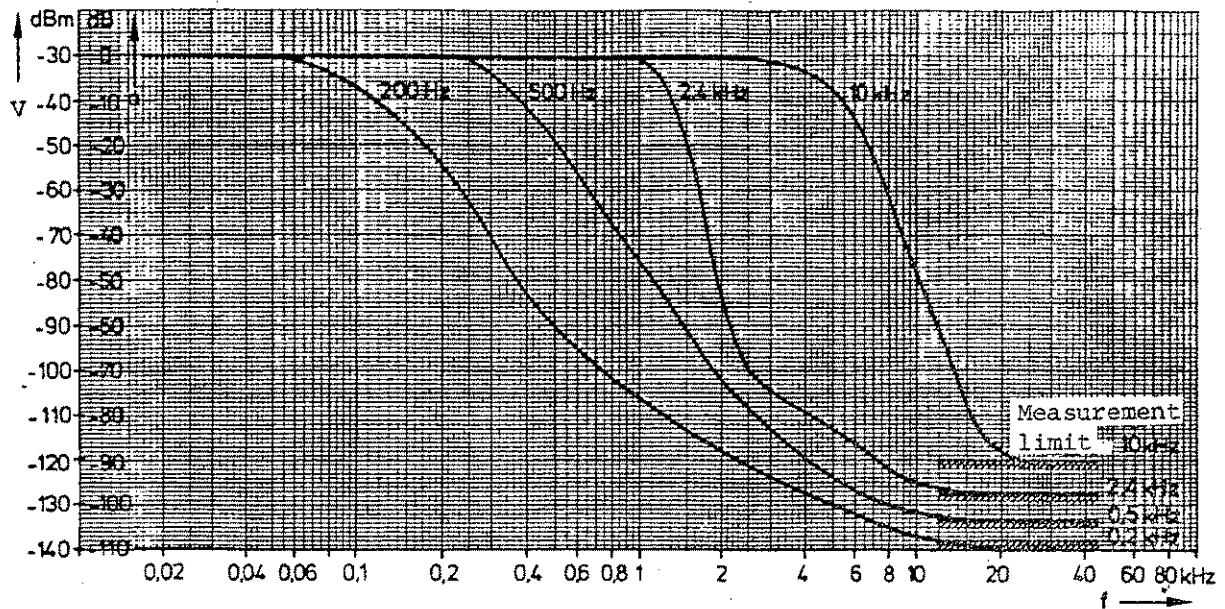

Fig. 2-1 Effective IF selectivity

2.3.4 Selection of Indicating Mode

Key 35 is used to select the type of rectifier for the level measurement.

The following indicating modes can be selected:

- AV. - the mean value of the input signal, more exactly, the linearly averaged value of the demodulated voltage at the output of the envelope demodulator, calibrated in the rms values of an unmodulated sinewave signal. Hence, with an unmodulated sinewave signal, the exact rms value is indicated, and with a symmetrically modulated AM signal, the rms value of the carrier. For more details about the influence of the modulation see section 2.4.1.2. The rms-value indication is used for measuring sinewaves with non-suppressed carrier.

PEAK - the peak value of the input signal, more exactly, the maximum demodulated voltage at the output of the envelope demodulator calibrated in the rms values of an unmodulated sinewave signal from which the same rectified voltage is obtained. Basically, the average and peak values of an unmodulated sinewave signal should give the same indication. The actual indications differ because the noise voltage at the output of the demodulator is weighted higher in peak-voltage measurements than in average-value measurements (see section 2.4.1.1). The peak-value indication is used for measuring the power of keyed carriers and the peak power of AM and SSB emissions.

CISPR - the quasi-peak value of the input signal with pulse weighting in accordance with CISPR Publ. 3 or 1. This indicating mode is identical with the indicating modes laid down in VDE 0876 for radio interference measurements according to VDE 0875. Since weighting according to CISPR 3 and CISPR 1 is defined in non-overlapping frequency ranges, weighting and IF bandwidth are automatically determined by the receiver frequency:

$f_{\text{receiver}} = 10 \text{ to } 149.9 \text{ kHz}$: weighting according to CISPR Publ. 3
operating range 20 dB
IF bandwidth 200 Hz

$f_{\text{receiver}} = 150 \text{ kHz to } 30 \text{ MHz}$: weighting according to CISPR Publ. 1
operating range 20 dB
IF bandwidth 10 kHz

(The typical value of the 10-kHz IF bandwidth is 9.5 kHz which complies exactly with the requirements laid down in the Appendix of CISPR Publ. 1.)

The time constant of an analog meter enters into the design of the pulse weighting in accordance with CISPR. The meter is simulated by a network with the same time constant. As a result, the response of the analog indication 14 approximately corresponds to that of a mechanical meter.

On account of this meter time constant and the charging and discharging time constant of the weighting circuit, settling time must be allowed for every new frequency and level setting before a valid test result can be obtained. It is, therefore, pointless to select a measuring time of less than 1 s (by means of MEAS. TIME 37) for radio interference measurements according to CISPR, above all for automatic measurements.

MIL - the peak value of the input signal as for PEAK, but as pulse spectral density: that is, with a different unit. The designation MIL originates from the American MIL (Military) Standards.

The pulse amplitude is for an IF bandwidth of 1 MHz because the pulse amplitude at the output of the IF filter is directly proportional to the pulse bandwidth of the filter, as long as the pulse frequency is low enough that the individual pulses at the output of the filter do not interfere with one another. The measured result is therefore indicated in $\mu\text{V}/\text{MHz}$, mV/MHz and $\text{dB}(\mu\text{V}/\text{MHz})$ and the peak value PEAK is increased by the bandwidth factor

$$\frac{1 \text{ MHz}}{B_{\text{IF}}} \quad \text{or} \quad 20 \log \frac{1 \text{ MHz}}{B_{\text{IF}}}$$

This bandwidth factor is

for $B_{\text{IF}} = 10 \text{ kHz}$	(more precisely, 9.5 kHz)	105.3	or	40.4 dB
2.4 kHz	(exactly 2.6 kHz)	384.6	or	51.7 dB
0.5 kHz	(exactly 0.63 kHz)	1587.3	or	64.0 dB
0.2 kHz	(exactly 0.20 kHz)	5000	or	74.0 dB

Pulses of a very low repetition frequency ($\text{PRF} < 50 \text{ Hz}$) would bring about approximately the same result with all the IF bandwidths as long as the RF input is not overloaded. Real pulse interference may contain more or less high pulse frequencies. Moreover, the individual pulses are often not correlated with each other but stochastically distributed over time. This may under certain circumstances considerably increase the indication in $\mu\text{V}/\text{MHz}$ or $\text{dB}(\mu\text{V}/\text{MHz})$ when switching over to the next lower bandwidth. In the most adverse case (where the interference has the characteristics of white noise) the indication is increased by the reciprocal of the square root of the IF bandwidth ratio.

$$\text{Increase} = \sqrt{\frac{B_{\text{IF wide}}}{B_{\text{IF narrow}}}} \quad \text{or} \quad 20 \log \sqrt{\frac{B_{\text{IF wide}}}{B_{\text{IF narrow}}}} = 10 \log \frac{B_{\text{IF wide}}}{B_{\text{IF narrow}}}$$

In each case, the result obtained with a bandwidth of 10 kHz is closest to the actual value of the interference. The 10-kHz bandwidth is a test bandwidth in compliance with the requirements of MIL standards.

If narrow-band interference (sinewave signals) is present in the noise spectrum the best way to detect it is to switch over to average-value indication.

The following diagram shows the difference in the weighting of pulses with the indicating modes AV., CISPR and PEAK or MIL as a function of the pulse frequency: (IF bandwidth 10 kHz).

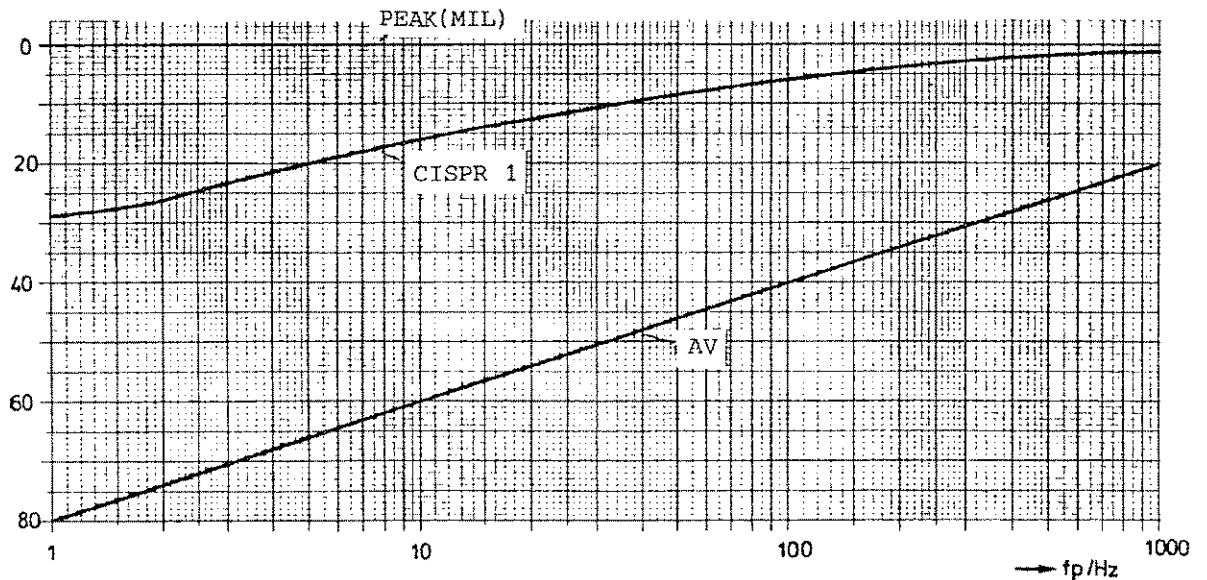

Fig. 2-2 Difference in pulse weighting with the indicating modes AV., CISPR and PEAK or MIL

This diagram shows that the average-value indication heavily suppresses pulses up to relatively high pulse frequencies while the full amplitude of sinewave signals is indicated.

MAX.MIN.- the range of variation of the input signal.

Single measurements at 100-ms intervals (i.e. the measuring time for the single measurement is 100 ms irrespective whether AV., PEAK, CISPR or MIL is switched on) are carried out in the selected MEAS. TIME 37 (0.2 to 1000 s). The highest (MAX.) and the lowest (MIN.) test result are at the end displayed together side by side. If the indication of the unit would otherwise run off the end of the 13-digit alphanumeric display 13, it is abbreviated (e.g. dB where stands for the unit which would be indicated without MAX.-MIN. measurement). To find out the actual unit you therefore just switch off MAX. MIN. 36 for a short time. The indicating mode MAX. MIN.

can be combined with any of the indicating modes AV., PEAK, CISPR and MIL.

Since it is not possible to take measurements while the setting of the RF level switch is being changed, fixed RF and IF attenuation (40) valves are selected in the MAX. MIN. indicating mode. Hence, the user must make sure that the operating range of the analog indication is not exceeded during the measurement. With the indicating modes AV., PEAK and MIL it is, therefore, best to select the 60 dB operating range. After each alteration of the front-panel settings the measurement starts again from the beginning. If the operating range is exceeded the display flashes.

2.3.5 Selection of the Operating Level Range

The selection of the operating level range has the following consequences:

- a) The range of the analog indication 14 is determined.
- b) The coverage of widely varying signals without the need for attenuator switching is ensured over wide operating ranges (40 and 60 dB).
- c) In a wide operating range the signal-to-noise ratio of the test and AF demodulators in the proximity of the maximum analog indication is higher than in a narrow operating range.
- d) With automatic RF attenuator setting, the level switch step size increases with the operating range. The relationship is as follows:

Table 2-1

Operating range dB	Level switch step size dB
20	10
40	20
60	30

Moreover, the switchover hysteresis and, as a result, the range of analog voltage at the A/D converter input is increased with automatic attenuator setting (key AUTO 43 depressed):

Table 2-2

Operating range dB	Range of the analog voltage below the max. analog indica- tion dB
20	-12 to 0
40	-25 to 0
60	-40 to 0

For automatic frequency scanning with large level jumps it is advisable to use as wide as possible an indicating range to minimize setting time.

- e) The maximum measuring accuracy slightly decreases with increasing operating range. The uniformity of the logarithmic level conversion is corrected by the overall calibration of the ESH 3 according to section 2.3.7 but the measuring accuracy is some tenths of a decibel higher in the 20-dB range than in the 40- and 60-dB ranges.
- f) The error of the average-value measurement increases with rising modulation depth in the operating ranges 40 and 60 dB (see section 2.4.1.2).
- g) In the CISPR indicating mode the 20 dB range is automatically selected (see section 2.3.4).

2.3.6 Setting of Attenuation and Measurement Ranges

The attenuator (RF level switch) built into the ESH 3 permits attenuation to be set over the range 0 to 140 dB. A 1-dB attenuator pad can be cut in or out, as desired for checking the linearity. In addition, the 30-kHz IF amplifier circuit is switchable in 10-dB steps and permits IF attenuation between 0 and 40 dB. With this and the 20, 40 and 60 dB operating level ranges, signals can be measured over the entire measurement range specified in the Technical Information (-30 to 137 dB (uV)).

2.3.6.1 Manual Setting

The RF and the IF attenuation can be set in steps using the key 40 and the pair of keys 41. It should, however, be borne in mind that the IF attenuation must not be too low (high noise voltage) nor too high (if high-level signals are simultaneously applied giving rise to intermodulation products, etc.). The RF attenuation is displayed on 8. The IF attenuation I can be determined from the lower limit A_1 of the analog indication 14 and the RF attenuation R:

$$I \text{ /dB} = A_1 + 30 - R.$$

Example: RF attenuation $R = 50$ dB; lower limit of the analog indication $A_1 = 40$ dB (μV). Accordingly, $I = 20$ dB.

A hint for rapid determination of I : if $R = A_1$,
 $I = 30$ dB.

If the key LIN. TEST 39 is pressed with manual attenuation setting the 1-dB attenuator pad is continuously in circuit. From the change in the level indication the user can recognize whether any non-linearity exists and must then cut off again the 1-dB attenuator pad. If there is no change in the level indication the signal level is in general not overloaded. The LED OVERDRIVEN 7 does not light even in the case of an obvious non-linearity unless one of the overload detection circuits indicates that a certain stage is overloaded (see functional diagram 335.8017 FS in the Appendix Vol. II).

2.3.6.2 Automatic Setting (Autoranging)

The RF attenuation is automatically set if the key AUTO 43 is pressed, the IF attenuation being fixed in steps determined by the OPERATING RANGE 33 (see section 2.3.5). The attenuation is always set such that the analog voltage at the input of the A/D converter lies in the upper half of the analog indication.

This is the range in which the signal-to-noise ratio is highest and, as a result, the measurement is more accurate.

The value of the IF attenuation is determined by the position of the key 42 and by the IF bandwidths and the indicating modes.

The following table lists the IF attenuation values with the key 42 in the LOW DIST. position, that means as high as possible an RF attenuation so that the input mixer is supplied as low as possible a signal level.

In the LOW NOISE position, all the IF attenuation values are 10 dB higher.

Table 2-3 IF attenuation values in the LOW DIST position

IF bandwidth/kHz	Indicating mode			
	AV.	PEAK	CISPR	MIL
0.2	20	10	10	10
0.5	20	20		20
2.4	20	20		20
10	20	30	20	30

The LOW NOISE position is preferable for measurements in simple situations because of the higher measuring accuracy. For measurements with very high interference levels and low signal levels the LOW DIST. position should be chosen, likewise for broadband interference measurements according to MIL and with an operating range of 60 dB. In the LOW NOISE position, the IF attenuation is reduced by 10 dB if the minimum RF attenuation is reached and the analog value falls below the minimum specified in 2.3.5. This corresponds to the LOW DIST. position. When the signal level goes up this IF attenuation will be cut in again immediately.

With average indication the IF attenuation is independent of the IF bandwidths in order to get the same precision of measurement for narrow and wide IF bandwidths with short measuring times. If the minimum RF attenuation is reached, the IF attenuation is reduced in 10-dB steps to the following minimum values:

E_{IF}/kHz	0.2	0.5	2.4	10
IF atten./dB	0	10	10	20

With automatic attenuation setting two measurements are always initiated for each test result when the key LIN. TEST 39 is pressed, the MEAS. TIME 37 applying to each single measurement. The result M1 of the measurement without the additional attenuator pad is indicated in the lefthand section of the display 13 and the difference M2 - M1 (M2 = test result with additional attenuator pad) in the righthand section of the display 13 (indication always in dB!).

Example: 51.8 dB* +0.2

The cause of a positive difference could be a desensitization of the input stages of the ESH 3 and the cause of a negative difference could be that the signal being indicated is a noise product that has developed in the ESH 3 (intermodulation, harmonics). When measuring field strength the cause could also be input voltage fluctuations.

With the indicating modes AV. and PEAK the 1-dB attenuator of the RF level switch is cut in for the LIN. TEST.

With the indicating modes CISPR and MIL a 10-dB attenuator is used instead of the 1-dB attenuator since differences between two measurements of the order of 1 dB are normal in the case of broadband noise. For this reason a 1-dB attenuator would be inappropriate. The LED OVERLOADED lights up to indicate non-linearity. The limit for the detection of non-linearity is a difference of >0.3 dB with the 1-dB attenuator and a difference of >2 dB with the 10-dB attenuator.

At switch-on of the ESH 3 10-dB RF attenuation is always out in regardless whether manual or automatic attenuation setting has been selected. This attenuation is maintained as a minimum attenuation with automatic attenuation setting until it is set to 0 dB after pressing the RF.IF key 40. If now the key AUTO 43 is pressed again the last 10-dB attenuator can be cut off. The 10-dB RF attenuation can be cut in again as a protective measure with automatic attenuation setting by pressing the key "+" 41.

2.3.7 Calibration

The calibration processes for level and frequency offset measurements are initiated by means of the key CAL. 15 :

- a) If the key 15 is pressed for a short time (< 3 s) the calibration of level and frequency offset are recalibrated at 1 MHz. Subsequently, at the frequency and bandwidth set the actual correction value is compared with the correction value measured under b) and in the case of an undue difference an error message is output. If the level calibration differs unduly from the correction value measured under b) recalibration takes place at 1 MHz (= reference frequency for the frequency correction values). This brief calibration is intended to compensate for gain drifts during operation.
- b) If the key 15 is pressed for a longer time (> 3 s) an overall calibration process is initiated during which the required frequency response correction values, the IF bandwidth correction values and the demodulator characteristics (in 10-dB steps) are measured and stored. This complete calibration replaces frequent recalibration upon each change of frequency and bandwidth and enhances the accuracy of the level measurement while fully maintaining the high speed of the measurement. The correction values are constant over an extended period of time and need not be reestablished every day. If a fault is found with the hardware during calibration an error message is output.

If the calibration values are lost for any reason, e. g. when the ESH 3 is switched off during the overall calibration process, all the correction values are reset to 0 and it is possible to continue with the measurement, with a reduced accuracy.

2.3.8 Setting the Data Output

The unit of the data output on display 13 is set by means of the keys dB (...) 9, dBm 10, SPEC. FUNC. 11 and V, A 12. The keys 9, 10 and 12 determine the unit for voltage, field-strength and RF current. The key 11 is dealt with in some detail in section 2.3.13.

dB(...)

- a) without test antenna/probe connected to ANTENNA CODE 47 , this key determines the units
 - for the voltage level dB μ V
(in decibels above 1 μ V)
 - with indicating mode MIL 35
for the broadband interference level dB μ V /MHz
 - in the operating mode TWOPORT
for the amplification dB
(attenuation is negative amplification)

- b) with test antenna/probe connected to ANTENNA CODE 47 , this key determines the units
 - for electrical or free-space field strength dB μ V /m
with MIL indicating mode dB μ V /mMHz
 - for RF current dB μ A
with MIL indicating mode dB μ A /MHz
 - for magnetic field strength dB μ A /m
with MIL indicating mode dB μ A /mMHz

dBm

without test antenna connected to ANTENNA CODE 47 , this key determines the unit

for the power level into 50 Ω dBm

Since the unit dBm is to be used only for power levels relative to 1 mW, only attenuators or amplifiers with defined power loss or gain may be coded.

Example: A resistive matching pad 75 Ω /50 Ω is to be connected and the indication is to be in dBm. The conversion factor of 10 dB can be coded at the input 47 . Hence, the matching pad must have a power attenuation of 10 dB. This would correspond to a voltage attenuation of 11.8 dB.

V, A

- a) without antenna connected to ANTENNA CODE 47 , this key determines the units
- for the voltage at 45 μV , mV, V
 - with the indicating mode MIL 35
for the pulse spectral density $\mu\text{V}/\text{MHz}$
 mV/MHz
 V/MHz
 kV/MHz
- Switching from $\mu\text{V} \longrightarrow \text{mV} \longrightarrow \text{V} \longrightarrow$
 $\longrightarrow \text{mV} \longrightarrow \mu\text{V}$ is without hysteresis effect.
- b) with test antenna/probe connected to ANTENNA CODE 47 , this key determines the following additional units
- for the electrical field strength $\mu\text{V}/\text{m}$ to V/m
with the indicating mode MIL 35 $\mu\text{V}/\text{mMHz}$ to
 kV/mMHz
 - for the RF current μA to A
with the indicating mode MIL 35 $\mu\text{A}/\text{MHz}$ to
 kA/MHz
 - for the magnetic field strength $\mu\text{A}/\text{m}$ to A/m
with the indicating mode MIL 35 $\mu\text{A}/\text{mMHz}$ to
 kA/mMHz

The function of the keys 9 , 10 and 12 is restricted as follows:

- ➔ In the operating mode TWOPORT 38 the amplification and attenuation can only be output in dB. The LED TWOPORT blinks when the key V, A 12 is pressed.
- ➔ "dBm" 10 can only be selected when there is no test antenna/probe connected to ANTENNA CODE 47 for field-strength or RF current measurement (see section 2.3.15). A constant power gain or loss may, however, be coded in 10-dB steps.

→ V, A 12 cannot be selected if the functions LIN. TEST 39 and MAX. MIN. 36 are switched on.

2.3.9 Setting the Measuring Time

The measuring time in seconds can be called up or altered by means of the key MEAS. TIME 37. This is true for voltage level measurement as well as for the special functions (SPEC. FUNC. 11). It corresponds either to the averaging time or to the peak-value measurement time for each single measured value depending on the selected indicating mode. With MAX. MIN. it is the total measuring time (see section 2.3.4). There is no fixed time for automatic frequency scanning but it is to a great extent determined by the measuring time for each single measurement (MEAS. TIME 37).

A measuring time of 0.1 s has been chosen for the basic setting. Unmodulated signals and signals of a relatively high modulation frequency can also be measured with a shorter measuring time. Signals at a lower frequency, in particular most broadband interference signals, require longer measuring times.

The measuring time is always counted from the moment when the RF level switch has been set to its final position and the input voltage at the A/D converter has reached a steady state.

The following measuring times can be set (in steps of 1, 2, 5, 10...):

With indicating modes AV., PEAK, CISPR and MIL 0.005 s to 100 s
With indicating mode MAX. MIN. 1 s to 1000 s

2.3.10 Setting the Display Time

The display time (DISPLAY TIME 34) is at least as long as the measuring time (MEAS. TIME 37). It can be longer than the measuring time if this is required for reading off the test result. The setting ranges are, however, the same as for the measuring time.

The display time is counted from the moment when the measuring time has elapsed. If the display time is longer than the measuring time the value last measured is read out upon termination of the last display function. After each new setting, the measuring time must have elapsed before the first value measured is displayed.

To explain the concepts of measuring time and display time by way of an example, we assume that a broadband interference with a pulse frequency of approx. 2 Hz is to be measured. To make sure that a pulse occurs in every test cycle we select a measuring time of 1 s. The pulse height can be observed during the measurement on the analog level indication 14. The arrival of a pulse does not trigger a measurement. The peak-voltage rectifier is discharged at the end of the measuring time and a new measurement starts.

The maximum value obtained during the measuring time is converted and indicated during the new measurement.

For measurements with linearity test (LIN. TEST 39) the display time is automatically at least twice the measuring time since each result involves two single measurements.

A long display time is of particular usefulness in automatic scanning operation, where short measuring times for each single measurement are desirable to ensure a short total scanning time, but each value measured that is above the minimum level set by means of MIN. LEVEL 27 should be displayed long enough to allow the user to note it down.

2.3.11 Selection of the Demodulation Modes

The demodulation modes 4 are selected as described in section 2.1. With the indicating mode CISPR, A3 demodulation is always selected unless OFF has been selected. In the TWOPORT operating mode the demodulation modes are automatically switched off.

Note the difference between A1 and A0:

With an unmodulated sinewave signal input at the receiver centre frequency, a beat note of 1 kHz is obtained with A1, and zero beat with A0.

2.3.12 Operating Modes TWOPORT and REM. FREQ. 38

In the TWOPORT operating mode the gain of a twoport network whose input is connected to GEN. 44 (Fig. 2-11) and output to RF 45 is measured in dB (attenuation is negative gain). The measurement range extends from -110 to +57 dB. The bandwidth is switched over to 0.2 kHz. The bandwidth selector is, however, not interlocked as it is also possible to connect modulators.

In the operating mode REM. FREQ. the ESH 3 operates as a tunable active filter with a bandwidth selected by means of IF BANDWIDTH 5. After reconversion the input signal applied to RF 45 is brought out at GEN. 44 at the same frequency as the original input and with an EMF of 86 dB (μ V). This permits the input signal frequency to be measured exactly by means of a frequency counter connected to 44 (cf. Frequency measured remotely with VHF-UHF receivers ESU 2 and ESM 2 by K. Danzeisen, News from R&S, No. 77, pp. 28 to 30).

2.3.13 Special Functions

The special functions 11 further extend the possible applications of the ESH 3. They are grouped as follows:

1. Test function SF10 to SF45
2. Automatic frequency scanning SF50 to SF53, SF90, SF91
3. Recorder control via 58 SF60 to SF71
4. Antenna factor SF80, SF81

The special functions 21 to 45 can be switched on either alone or together with others. In the latter case, first the result, say, of the level measurement and then successively the results of all other special functions are read or printed out or sent to the IEC-bus controller.

Storage:

The special functions 10 to 45 and 52, 53 can be assigned individually to any device setting in the registers 1 to (5) to 9 and thus be stored.

The special functions 50, 51 and 60 to 91 are each valid for all storage registers. Hence, it is not possible to assign, say, the special function 70 (polygonal curve) to register 1 and the special function 71 (line spectrum) to register 2.

For switching on the special functions, the following code is used (entry after pressing the key 11 , then press ENTR 18).

Table 2-4

Function	Codes		Data Output	
		Basic Setting = RCL0	Symbol	Unit
Basic setting	00		None	
Level measurement	11	10*	(see 2.3.8)	
Modulation depth	21	20	m	%
Pos. modulation peak	23	22	m+	%
Neg. modulation peak	25 ON	24 OFF	m-	%
Frequency offset	31	30	Offset	kHz
Frequency deviation	41	40	Δf	kHz
Pos. peak deviation	43	42	$\Delta f+$	kHz
Neg. peak deviation	45	44	$\Delta f-$	kHz
Automatic repetition of frequency scan (50: single scan)	51	50	None	
Lin. step size lin./log. (52: lin.)	53	52		
Log. frequency axis for XY recorders (60: lin. frequency axis)	61	60	None	
Recorder coding				
Coding via 58 enabled		62	None	
Coding via 58 disabled = no recorder	63		None	
Disabled: XT recorder	64		None	
Disabled: XY recorder	65		None	
Disabled: ZSG 3	66		None	
Frequency line spectrum for XY recorder (70: polygonal curve)	71	70	None	
Indication of electrical field strength		80		$\mu V/m$ dB($\mu V/m$)
Indication of magnetic field strength (with correction -51.5 dB)	81			$\mu A/m$ dB($\mu A/m$)
Fast frequency scan (90: normal, see 2.3.2.1.)	91	90	None	

* With RCL0 always the level measurement (SF11) is switched on.

Upon entry of code 00 the ESH 3 is switched over to level measurement. This basic setting corresponds to the codes 11, 20, 22, 24, 30, 40, 42, 44, 52, 60, 62, 70, 80. The basic setting switches off all special functions. This basic setting is also obtained with the overall basic setting "RC0" or "Device clear" via LEC bus connector (see section 2.2.4).

When calling the special functions entered, the key 11 is pressed repeatedly until no new code is output. All special functions switched off are not read out, i.e. only codes that are listed in the column ON (Table 2-4) are read out.

If the level measurement is not switched off after the test result has been output the measured result of the next special function 21 to 45 switched on is output in the format listed under "Data output".

For measuring accuracy and resolution of the data output see the relevant specifications in the Technical Information.

In general, the following should be observed:

- a) A high signal-to-noise ratio also enhances the accuracy of modulation-depth and frequency-deviation measurements. In modulation-depth measurement as well as in frequency-deviation measurement, peak values are measured, where the noise content of the test signal is particularly critical as explained in section 2.4.1.1.
- b) For modulation-depth measurements a linear demodulator is required. This is only provided in the 20-dB operating range. For this reason, the ESH 3 is always switched over to the 20-dB operating range when measuring modulation depth. This is also true for automatic frequency scanning, for example, when measuring level and modulation depth for radio monitoring purposes. Since automatic frequency scanning obviously requires autoranging as described in 2.3.6 there is only the choice between LOW DIST. and LOW NOISE.

Frequency steps in a constant ratio (logarithmic) are particularly important for automatic scanning in interference measurements. The special functions 52 LIN STEP and 53 LOG STEP permit individual selection of scanning ranges with frequency steps in a constant number of Hz (linear) or ratio. The special function 53 is used to automatically enter the menu for STEP SIZE in %.

For reasons of simplicity the ESH 3 rounds the values off to steps of 100%, 50%, 25% to 0.01%. The switchover 53 \longleftrightarrow 52 automatically clears the step size memory.

For logarithmic display on the frequency axis (SF 61: X-LOG) a ratio

$$\frac{f_{\text{START}}}{f_{\text{STOP}}} > 1.4$$

is required; otherwise an error is indicated at the start of automatic scanning.

If an antenna is connected to socket 47 which causes a field-strength indication in $\mu\text{V}/\text{m}$ (e.g. ESH 2-Z2, ESH 2-Z4), the special function 81 changes the indication to $\mu\text{A}/\text{m}$ (magnetic field strength) and automatically takes into account the correction value -51.5 dB (corresponding to $20 \log \frac{\Omega}{\Omega_0}$). The magnetic field strength measurement mode can, however, still be selected via socket 47 if the conversion factor is coded properly according to 2.3.15.

Any entry of special functions is to be terminated by ENTR 18.

2.3.14 Storage and Recalling of Settings by Means of STO and RCL

Up to nine different sets of control settings can be stored. By pressing the key STO 16 and entering a figure (1 to 9) on the keyboard 32, a complete set of control settings is stored in the associated CMOS RAM storage area. In the storage locations 1 to 5, the data for automatic frequency scanning (26, 27, 29, 30, 31) are stored with each of the five settings. In the storage locations 6 to 9, on the contrary, the setting data stored does not include the data for automatic frequency scanning. In addition, a storage area is provided for the last setting before switching off the ESH 3. When switching the ESH 3 back on this setting is restored (exception: 10-dB RF attenuation, see section 2.3.6).

Since the complete CMOS-RAM memory is buffered by a NiCd battery, the stored settings are preserved even after the ESH 3 has been switched off. The software provides for prevention of mixups due to storage of incomplete data sets.

The key RCL 16 and entry of the same figure (1 to 9) permits the setting stored by means of STO 16 to be recalled. Since it is possible to include more than one automatic frequency scan in a single operation (see section 2.3.2), it is sufficient, if the LED 25 is on, to enter the figure referring to the desired frequency ranges previously stored on the keyboard 32 and press the key RUN 28.

For calling up the basic setting, RCL \emptyset is entered according to section 2.2.3.

2.3.15 Connection of Test Antennas and Probes

Probes for high-impedance voltage measurements (Active Probe ESH 2-Z2 and Passive Probe ESH 2-Z3), for RF current measurements (Clamp-on RF Current Probe ESH 2-Z1), and antennas for field-strength measurements (Rod Antenna HFH 2-Z1; Loop Antenna 10 kHz to 30 MHz HFH 2-Z2; Loop Antenna 10 kHz to 150 kHz (1 MHz) HFH 2-Z3, and Inductive Probe HFH 2-Z4) are connected to the RF input 45 and the supply and coding socket 47.

For measuring the field strength in shielded booths, the ESH 3 is normally operated outside the booth. The shielding of the supply and coding cable must be passed through the wall of the booth so that no EMI is introduced in the booth.

All the active antennas/probes (ESH 2-Z2, HFH 2-Z1, -Z2, Z3) obtain their supply voltages via socket 47. The conversion factors (coded in 10-dB steps) and the quantity to be measured (field strength, voltage, current) are communicated to the ESH 3 via the coding inputs so that the test result is read out on the display 13 with the correct unit.

If an antenna is connected to socket 47 which causes a field-strength indication in $\mu\text{V}/\text{m}$ (e.g. ESH 2-Z2, ESH 2-Z4), the special function 81 changes the indication to $\mu\text{A}/\text{m}$ (magnetic field strength) and automatically takes into account the correction value -51.5 dB (corresponding to $20 \log \frac{Z_0}{\Omega}$). The magnetic field strength measurement mode can, however, still be selected via socket 47.

All R&S antennas/probes are fitted with appropriately coded connectors. Since the ESH 3 has a coding input for magnetic field strength ($\mu\text{A}/\text{m}$), the coding connector of the Inductive Probe can be rewired, if required. The conversion factor is then changed from 80 to 30 dB and the unit from $\mu\text{V}/\text{m}$ to $\mu\text{A}/\text{m}$.

Since the coding inputs may also be used for connection of antennas/probes from other manufacturers, the pin allocation of the socket 47 is given below (viewing the front panel):

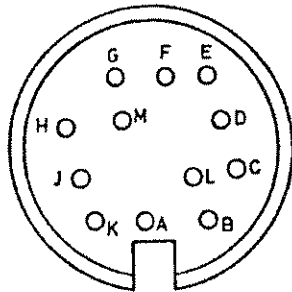

- A: Ground
- B: +10 V (max. 50 mA)
- C: $\mu\text{V}/\text{m}$ (el. field strength)
- D: μA (current)
- E: 10 dB
- F: 20 dB
- G: 40 dB
- H: 80 dB
- J: $\mu\text{A}/\text{m}$ (magn. field strength)
- K: -10 V (max. 50 mA)
- L: Not wired
- M: Reverses sign of the factor

Fig. 2-3 Pin allocation of the 12-way female connector 47 (Tuchel type).

In remote operation of the ESH 3 via the IEC bus, the antenna coding can be suppressed by the instruction "ZØ".

For coding, a 12-way male Tuchel is used (R&S order number 018.5362.00). The coding inputs must be connected to ground.

Example: An antenna has an antenna factor of 30 dB, i.e. a field strength of 30 dB ($\mu\text{V}/\text{M}$) produces a voltage of 0 dB (μV) at the RF input. The pins C, E and F must be connected to ground.

The "reverses sign of the factor" coding input permits an amplifier to be included in the coding.

Example: An amplifier with a constant gain of 10 dB is connected to the input of the ESH 3. The input voltage to the amplifier is to be displayed. Therefore, pins E and M are to be connected to ground.

2.3.16 Data Output on a Listen Only Recording Device (Printer, Magnetic Tape Memory, etc.)

To facilitate data logging a printer with an IEC-625 (IEEE-488) interface can be connected to the IEC bus connector 57 of the ESH 3. The printer must be switched over to Listen Only operation. Thus data can be sent from the ESH 3 to the printer.

In the place of the printer another Listen Only device such as a cartridge tape drive or disk drive may be connected to temporarily store the test results for evaluation by a computer.

All measured values, together with the particular test frequency and the complete units, are output in a fixed format, separated by comma and space (SP), in one record delimited by carriage return (CR) and line feed (LF).

Example:

Frequency MHz	* Level dB _u V	Mod. depth %	Offset kHz	Dev. kHz	CRLF
12,3456 MHz	* 117.4 dB _u V	13 %	0.12 kHz	0.15 kHz	CRLF

Normally a space is output instead of the * before the level output. If the level falls below the operating range a U is output; if it exceeds the operating range an H and in the case of an overload, an X.

The format is designed to obtain easily readable tables of long test series. If the readout or a special function is switched over, the format is changed. The ESH 3 offers three possibilities for Talk Only output:

a) Manual operation:

To prevent every measured value read out on the display 13 being also printed, the user can decide which test result he wants to be printed by means of the key TALK 19. When the TALK-Button is depressed, a new measuring procedure is triggered, the result of which will be printed.

b) Continuous observation at a fixed frequency:

In order to automatically obtain an output after each individual measurement the ESH 3 is switched to automatic pseudo-frequency-scanning with $f_{\text{START}} = f_{\text{STOP}}$.

c) Values measured over one or several frequency bands:

The test results are output if the level is above minimum level (MIN. LEVEL 27) at the particular frequency.

To facilitate output on a printer, the contents of the menu output on the display 13 can be output in the TALK ONLY mode by pressing the key TALK 19 .

2.3.17 IF, AF and Recorder Outputs

A number of outputs are provided for signal evaluation by means of oscilloscopes, analyzers and YT recorders:

- ➔ 75-MHz IF output 49 for connection of a 75-MHz panoramic receiver (e.g. MSU(P)) or of an analyzer.
- ➔ 30-MHz IF output 48 for connection of an oscilloscope, an IF analyzer, a precision modulation-depth or deviation meter or a teletype demodulator (e.g. NZ 47/10).
- ➔ AM demodulator output 50 for investigation of the demodulated AF with amplitude modulation signals (DC coupled).
- ➔ FM demodulator output 51 for investigation of the demodulated AF with frequency modulation signals (DC coupled).
- ➔ CISPR level recording output 52 , with built-in low-pass filter simulating meter response, for driving a YT recorder in the CISPR indicating mode.
- ➔ AV./PEAK level recording output 53 for driving a YT recorder in the AV./PEAK indicating mode.
- ➔ Frequency offset recording output 54 for recording the frequency offset of sinewave signals.

2.3.18 Operation of the ESH 3 Using an External Reference Frequency

To enhance the frequency accuracy of the ESH 3 it is possible to connect an external frequency standard to the input 55 . The EMF (sinewave) required from the reference source is 1 V with an output impedance of 50 Ω ; the ESH 3 can be switched to a reference frequency of 5 or 10 MHz.

2.3.19 Connection of Recorders to the Output 58

The 24-way socket XY RECORDER 58 contains analog outputs which are driven from the microprocessor in the ESH 3 via D/A converters. YT, XY and radio monitoring recorders (ZSG 3) for graphic representation of the automatic scanning operations of the ESH 3 can be connected to these analog outputs.

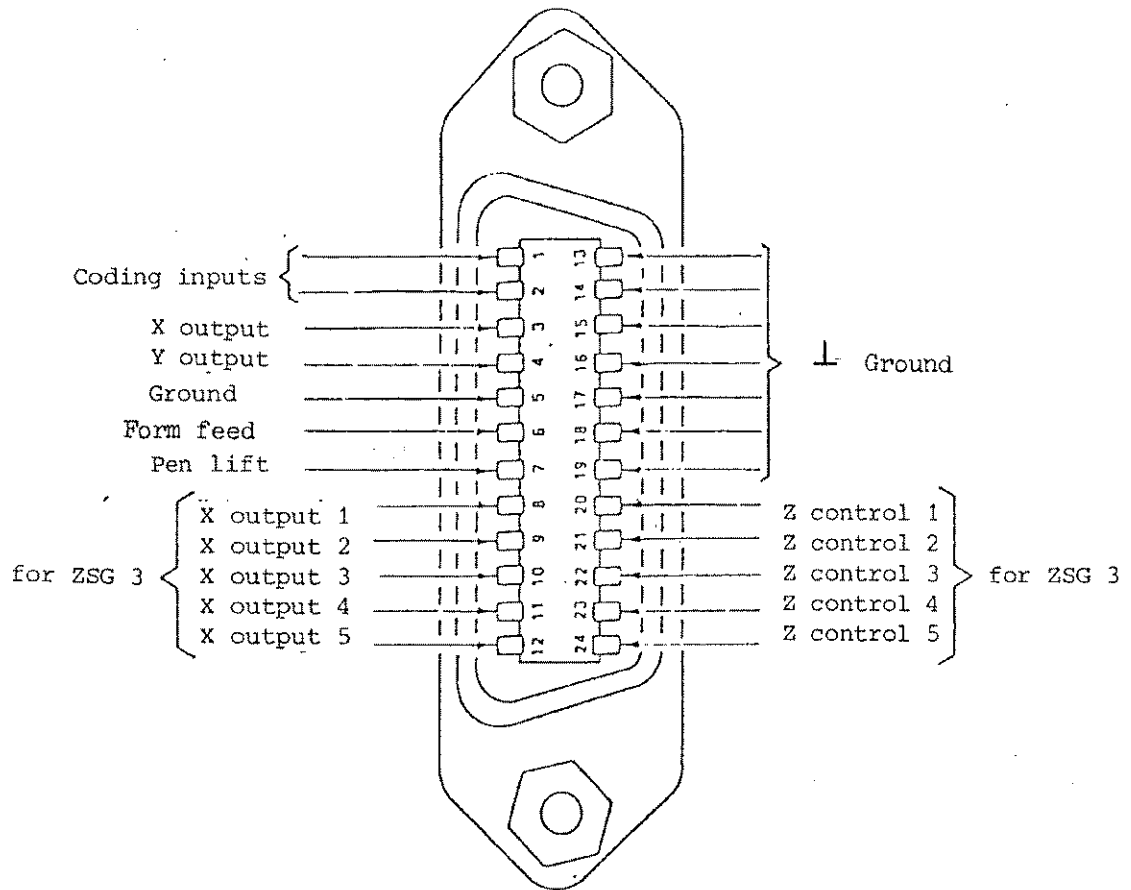

Fig. 2-4 Pin allocation of the recorder output 58.

Two coding inputs are provided on the ESH 3 for identification of the recorder type connected (YT, XY or ZSG 3). Coding is possible for one type, but five units of type ZSG 3 can be connected.

Table 2-5 Coding of recorder type (with special function 62)

	Pin 1	Pin 2
No recorder	N/C	N/C
YT recorder	To ground	N/C
XY recorder	N/C	To ground
ZSG 3 (Radio Monitoring Recorder)	To ground	To ground

If a recorder is connected to the ESH 3 the main processor gets an interrupt command, i.e. the recorder code is immediately identified and taken into account in automatic scanning operations. The settling times of XY recorders play an important role as waiting periods in the scanning process. If the fastest

possible automatic frequency scanning is desired, these waiting periods are inconvenient. In this case, either the plug must be disconnected from recorder output 58 or special function 63 selected. In order to simplify parallel operation of several types of recorders (e.g. ZSG3 and ZSKT) in radiomonitoring systems, the recorder type can also be selected using a special function code:

SF 64	YT recorder
SF 65	XY recorder
SF 66	ZSG 3

Coding for output 58 is disabled when one of the special functions 63 to 68 is selected.

When the ESH 3 is remote-controlled via IEC bus, command $Y\emptyset$ is used with basic setting (SF 62) for suppressing the coding for the recorder socket 58.

Except for one cable, ESH 3 to ZSKT (as XY recorder), ESH3-Z1 Ident No. 349.6011.02, ready-made cables cannot be supplied with the receiver since any commercial YT and XY recorder may be used besides the Radio Monitoring Recorder ZSG 3.

The following connectors are required for the connecting cables:

24-way male connector for ESH 3 recorder output; Ident No. 080.2711.00
Amphenol ordering number: 5730240.

36-way elbow connector for the Radio Monitoring Recorder ZSG 3 and the XY Recorder ZSK 2; Ident No. 247.7055.00
Amphenol ordering number: C57-159A 5036P

6-way round connector for the XYT Recorder ZSKT; Ident No. 018.6646.00
Amphenol-Tuchel ordering number: T 3400/1

Banana plug for the XY Recorder ZSK 2 and the XYT Recorder ZSKT;
available from any electronics dealer.

See section 2.3.19.1 for the wiring scheme.

No wiring of code connections is needed if the recorder code is input via special functions. When a ZSKT and a ZSG 3 are connected in parallel, the "format advance" connector on the ZSKT must remain free. The ESH 3 is to be switched off while ZSG 3's are driven.

Logic level at pins "pen lift" and "form feed":

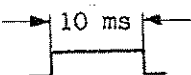
Pen lift (TTL level) L = pen up H = pen down
Form feed (TTL level) 

2.3.19.1 Wiring Scheme for Connecting Cables

a) ESH 3 - ZSKT as a YT recorder

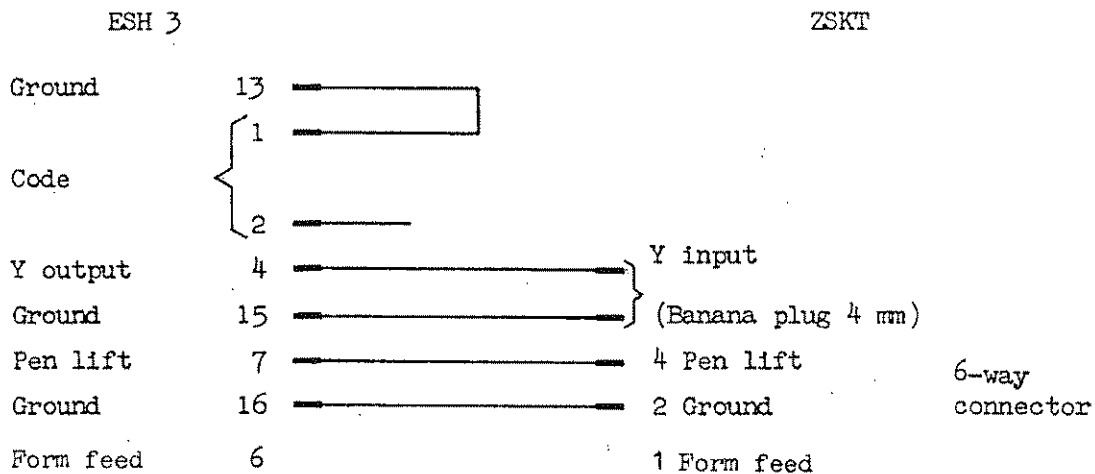

b) ESH 3 ZSKT as a XY recorder (ESH3-Z1 IN 349.6011.00)

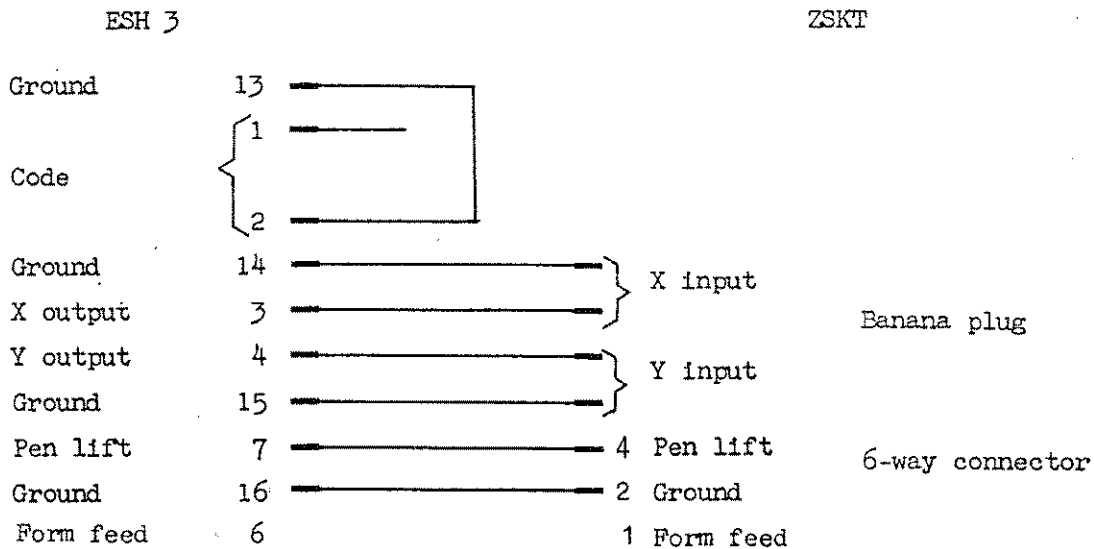

c) ESH 3 - ZSG 3 (1 to 5 units)

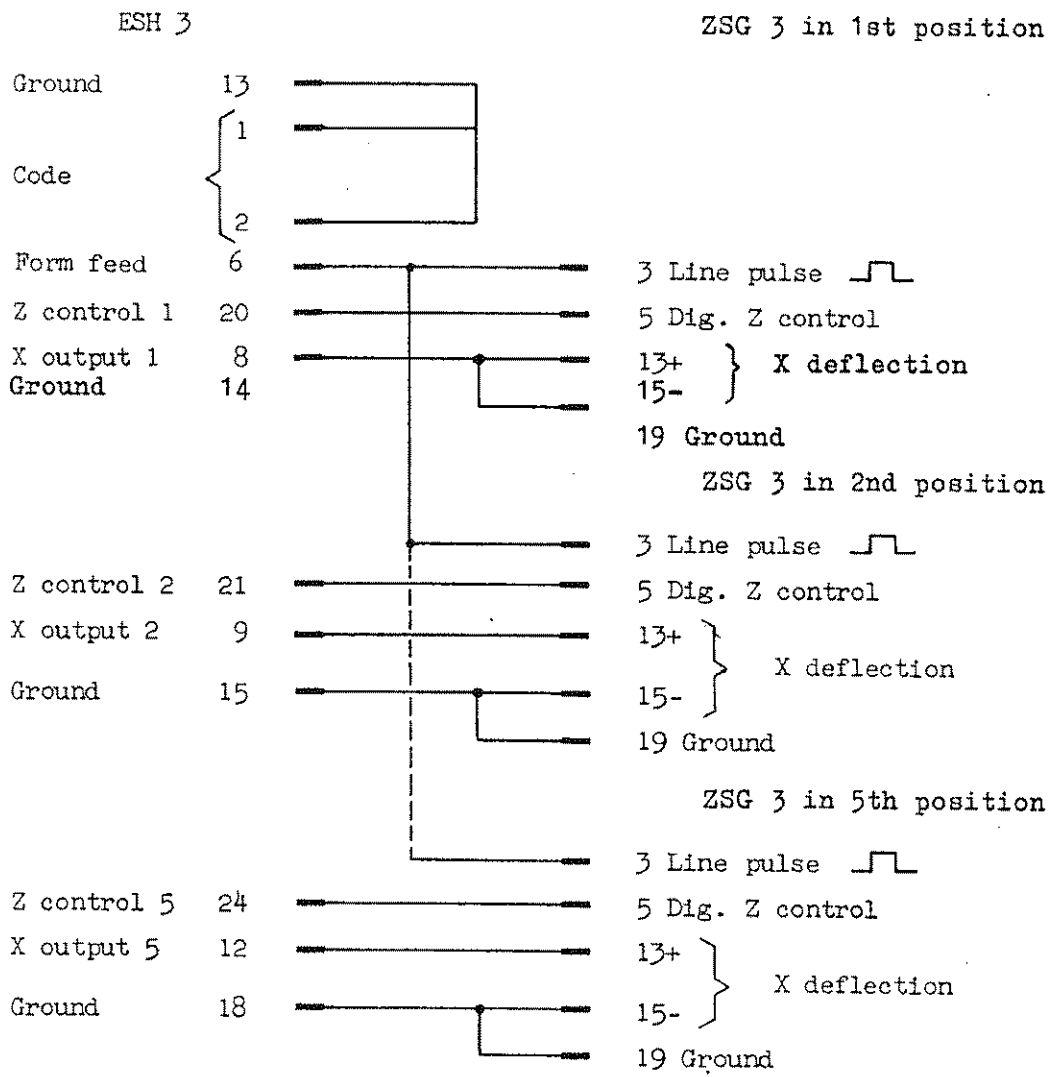

2.3.19.2 Setting the ESH 3 for Output to a Recorder

2.3.19.2.1 YT Recorder (Y = level; T = automatic time base)

Long-term measurement of level fluctuations at a particular frequency:

Note, when setting the ESH 3: start frequency = stop frequency. After pressing the key RUN 28, the pen is applied and the level is recorded (a "polygonal" curve is produced, in which the points representing each level measurement are joined by straight lines) until the key STOP is pressed. Simultaneously data can be output in the Talk Only mode.

Calibration of the Y axis: As long as RUN and MAX. LEVEL are not pressed, the Y voltage is 0 V. If MAX. LEVEL is pressed, the Y voltage goes to its maximum (= +10 V).

2.3.19.2.2 XY Recorder (Y = level, X = frequency)

Special functions are available for recording frequency spectra and frequency response:

Special function 70 (polygonal curve, CONTIN)

For displaying the envelope of spectra and curves, as with two-port frequency-response measurements.

Special function 71 (frequency line spectrum, DISCRET)

Graphic display of amplitude of sinewave signals whose spacing exceeds the IF bandwidth (e.g. narrowband line interferences, spectra of harmonics and of a radio broadcasting band).

Special function 60 (linear frequency axis, X-LIN)

Linear division of X-axis; used for all narrowband recordings such as radio broadcasting bands.

Special function 61 (log. frequency axis, X-LOG)

Logarithmic division of X-axis; used for wideband recordings, (e.g. attenuation curve of a lowpass filter, display of noise peaks).

Special function 52 (lin. step size, LIN-STEP)

Equal-sized steps of frequency scan, used for narrowband frequency scans: measurement of harmonics or step size of a channel pattern.

Special function 53 (log. step size, LOG-STEP)

Steps of frequency scan proportional to the last set frequency. Used for recording wideband spectra and lowpass filters.

Special functions 50 and 51

Standard setting is normally sufficient (SF50, single scan). For frequency recording with a modified ZSKT, special function 51 (repeated frequency scan) is useful: The ZSKT is set in XYT operation to slow paper advance. With each scan, a slightly shifted XY recording of the frequency band is obtained. Thus time-responsive level variations can be easily identified.

Special function 52/53 are individually stored with command S70 in one of registers 1 to 5; they can be combined as required. All other special functions concerning the recorder control apply in general to the selected scan.

The settling times of a normal XY recorder (ZSKT) are taken into consideration. After pressing the key RUN 28, the pen is applied and a single recording operation is carried out. Simultaneously data can be output in the Talk Only mode. In multiple frequency scanning (e.g. 1, 2, 3 RUN), the limit values of f_{START} , f_{STOP} , MIN. LEVEL and MAX. LEVEL determine the scaling of the recording.

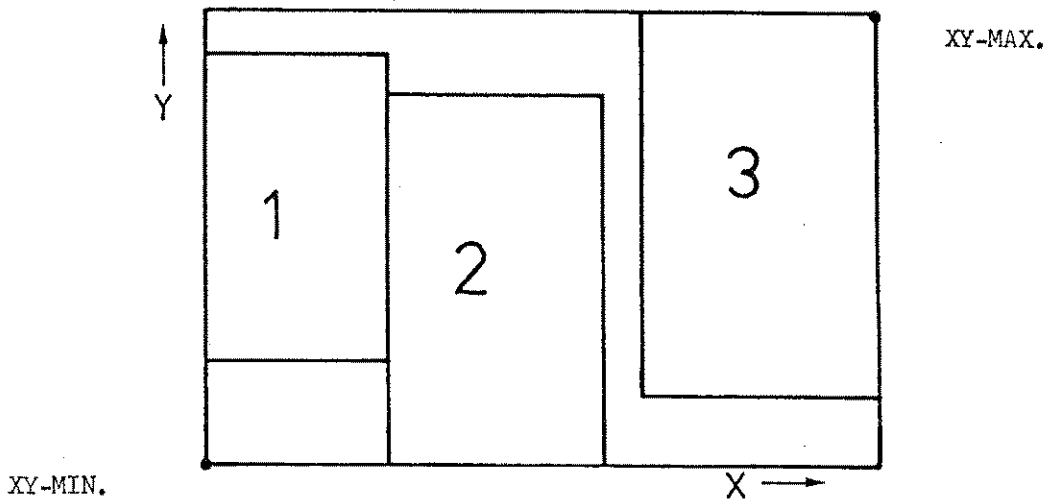

Fig. 2-5 Example of possible allocation of start and stop frequencies in three subranges for output to an XY recorder

For frequently performed recordings it is recommended to prepare forms with the axes, limit values, and a field for the test item and the date, already printed on the sheet.

Calibration of X and Y axes: As long as neither RUN nor MAX. LEVEL is pressed the X and Y voltages are 0 V. If MAX. LEVEL is pressed the X and Y voltages go to their maximum (= +10 V).

2.3.19.2.3 Radio Monitoring Recorder ZSG 3

The Radio Monitoring Recorder ZSG 3 is used for recording the band occupancy over a longer period of time. The minimum levels entered for each frequency range determine the threshold above which a mark is produced on the recording paper. After all the frequency ranges called up at the start (1, 2, 3 RUN) have been scanned, all the ZSG 3s connected are sent a line feed, and recording automatically begins again at the first start frequency.

If no range number is called at the start, the current frequency band (newly entered values or called up by means of RCL) is recorded by means of the recorder at X output 1 (see wiring diagram).

For fastest possible recording of the frequency bands, there is no precise level measurement made, but only a check whether the level falls below the minimum value. For this reason, simultaneous Talk Only output is not possible. An error message (see section 2.3.20) is obtained if the following settings have been made on the ESH 3: TWOPORT, MAX./MIN., AUTO, SPEC. FUNC. 91. These settings must, therefore, be switched off prior to storing the frequency range. If the 40-dB or 60-dB operating range has been selected switchover to the correct RF attenuation and to the 20-dB operating range takes place when the scanning operation is started. It is, however, advisable to adjust the RF and IF attenuation to the desired measurement range for the 20-dB operating range. Any of the indicating modes can be used. Average-value indication with a measuring time of 5 ms is recommended.

Setting of frequency markers: Set start and stop frequencies of required frequency range. After pressing "RUN" press "STOP" once. Now the frequency of the ESH 3 can be set to the required frequency marker, whereby the X deflection of the ZSG 3 concerned is accurately set.

2.3.20 Error Messages

Error messages from the ESH 3 signal faulty operation, illegal or missing data

entries and recognizable internal failures. They are output on the display 13, which reads out ERROR and a two-digit code number.

Table 2-6 Error code list

ø1	Frequency entered above limit	
ø2	Frequency entered below limit	
ø3	CAL: CHECK.Comparison frequency response correction/ current value > 0,5 dB	
ø4	No listener on IEC bus (Fault in IEC-bus controller)	
ø5	Level or offset calibration is not accomplished within fixed time (hardware error)	
ø7	Correction value at CAL. TOTAL > 6 dB; complete calibration discontinued.	
ø8	Memory register not occupied if RCL	
1ø	+10 V	} Failure of a supply voltage (the failure of the +5-V supply voltage cannot be output)
11	-10 V	
12	+12 V	
13	+25 V	
14	+30 V	
2ø	Current register	
21	Register 1	} At start of automatic frequency scan one or more values are not defined.
22	Register 2	
23	Register 3	
24	Register 4	
25	Register 5	
3ø	START frequency > STOP frequency	
31	START frequency = STOP frequency and XY recorder or ZSG 3 connected.	
32	MAX. level \leq MIN. level	
33	SPEC. FUNC. 61 Logic X axis and $\frac{f_{stop}}{f_{start}} < 1.4$	
4ø	ZSG 3 error: Error message if SPEC. FUNC. 61 is selected at SCAN RUN with ZSG 3.	
51	} One (or several) synthesizer loop(s) - 1 to 5 - is (are) not locked.	
52		
53		
54		
55		

2.3.21 Control of the ESH 3 via IEC Bus⁺)

The Test Receiver ESH 3 is provided with a remote-control interface to IEC Publication 625-1 for transfer of setting and measured data using a byte-serial bus system. IEC-bus connector 57 is located on the rear panel of the test receiver. The pin allocation can be seen in Fig. 2-6.

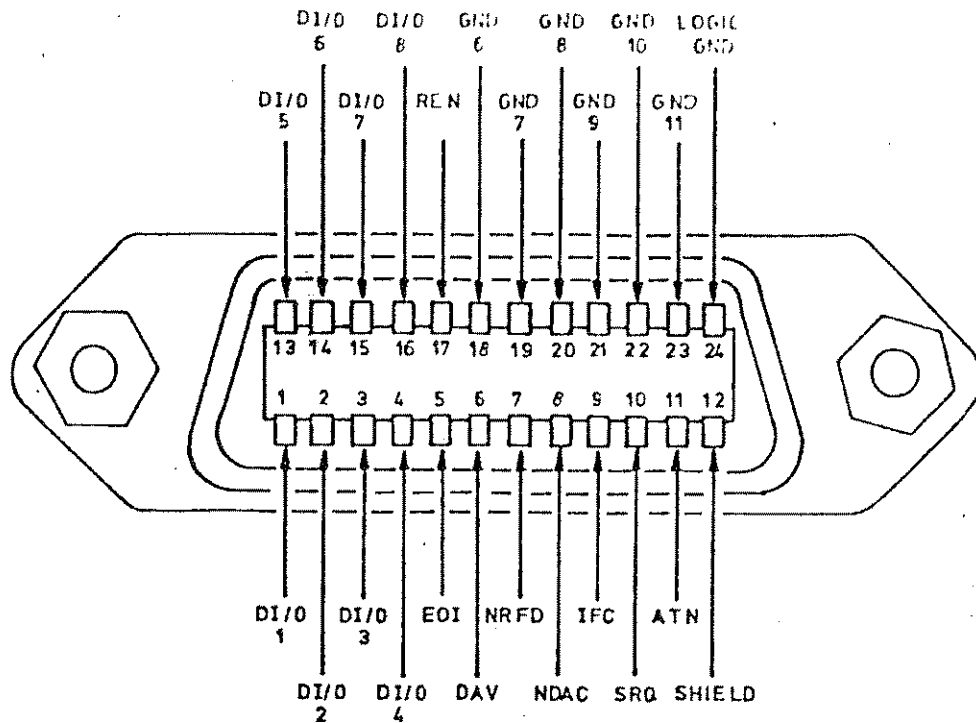

Fig. 2-6 Pin allocation of the IEC-bus connector

For data transfer exclusively ASCII characters (see Table 2.18) are used. For the interface specifications (control lines, handshake lines, data lines) and data transfer sequence see IEC standard.

⁺) A Technical Information "Driver Software ESH3" can be obtained from Rohde & Schwarz free of charge for either the R&S Process Controllers PPC/PUC and the Tektronix Desk-top Computing Systems 4051/4052 with the instruction sequences applicable to these processors. For information on available application software, contact your nearest R&S distributor.

2.3.21.1 Setting the Device Address/Talk Only Mode

The listener and the talker address are set together by means of the coding switches 56 in accordance with Table 2-17. The receiver is set at the factory to the listener address "1" and to the talker address "Q". This corresponds to device address 17 (e.g. for use with R&S Process Controller PPC).

The Talk Only mode can be selected by means of the coding switch S6 of 56 which permits the ESH 3 to send data to a Listen Only device, such as a printer, via the IEC bus.

NOTE: The Test Receiver ESH 3 need not be switched off when changing the device address or switching the Talk Only mode on or off.

2.3.21.2 Interface Functions

The ESH 3 implements the following interface functions:

SH1	Source handshake function, complete capability
AH1	Acceptor handshake function, complete capability
T5	Talker function, capability to answer serial poll, unaddressing if MLA, Talk Only mode
L4	Listener function, unaddressing if MTA
SR1	Service request, complete capability
RL1	Remote/local switchover function, complete capability
PP1	Parallel poll function,, remote-controllable configuration
DC1	Device clear function, complete capability
DT1	Device trigger function, complete capability
CO	Control function, <u>no</u> capability.

2.3.21.3 Setting Instructions

The following describes the setting instructions for remote control, the program data and their format as well as the functions that cannot be set manually. The Test Receiver ESH 3 responds to the IEC-bus setting instructions and data in remote operation exactly as it does to direct, manually keyed in instructions in local operation. Therefore the same sequence of settings that is used for manual operation can be used as a basis for preparing the controller to set the receiver functions and measuring procedures.

The programming instructions consist of an alphanumeric header, the numeric actual data content and a delimiter which separates several instructions from each other or delimits a sequence of instructions. The header consists of one or two alphanumeric characters (ASCII upper-case letters); the actual data content consists of one or several numeric characters (0, 1 to 9, decimal point, polarity sign) and the delimiter character.

Table 2-7 Delimiter characters

Symbol	Name	ASCII decimal equivalent	Application
,	Comma	44	} Separates individual instructions
;	Semicolon	59	
CR	Carriage Return	13	} Terminates input
LF	Line Feed	10	
ETX	End of Text	3	

Any of the terminating delimiters can be used.

Example: IECOUT 17, "command 1, command 2;
 command 3" /CR/

(The PPC automatically sends the delimiter "CR".)

Table 2-8 Key functions

Instruction code	Function	Key
A1 A2	Low noise Low dist.	Autoranging <u>43</u> , <u>42</u>
B1 B2 B3 B4	10 kHz 2.4 kHz 0.5 kHz 0.2 kHz	IF bandwidth <u>5</u>
C1 C2	Check Total	Calibration <u>15</u>
D0 D1 D2 D3 D4 D5 D6	AF off A0 A1 A3 A3J A3J F3	Demodulation <u>4</u>
G0 G1	OFF ON	Lin. test <u>39</u>
K0 K1	OFF ON	MAX. MIN. <u>36</u>
L1 L2 L3	20 dB 40 dB 60 dB	Operating range <u>33</u>
M0 M1 M2	Gen. off Remote freq. meas. Twoport meas.	Operating mode <u>38</u>
N1 N2 N3 N4	AV. PEAK CISPR MIL	Indicating mode <u>35</u>
O1 O2 O3	dB (...) dEm V/A	Data output <u>9</u> , <u>10</u> , <u>12</u>

2.3.21.3.1 Data Entry

All the data entry commands start with a header which consists of two alphanumeric characters. The actual data contents consist of a string of ASCII decimal figures with an optional decimal point, which may be preceded by a - sign. The number of significant digits that are accepted and processed by the test receiver depends on the current menu input:

Frequency 6 digits, unit MHz
 Time 4 digits, unit s
 Level 4 digits, unit dB*)

*) (depending on setting, antenna or probe connected, etc.)

The following examples of receiver frequency programming illustrate the possible input formats:

"FR 12" ≅ "FR 12.0" ≅ "FR 12.0000"
 "FR .123" ≅ "FR 0.123" ≅ "FR 00.1230"
 "FR 12.34566789" ≅ "FR 12.3456"

A special rule applies to the control commands for automatic scanning as they simulate exactly the manual entry. There is no data required for the commands "Stop" and "Stop and Reset" but the actual start command RUN requires a data format of variable length (0 to 5 characters) depending on the desired scan ranges.

Table 2-9 Scanning instructions

Instruction code	Data	Function
SR	-, Z1, Z1 Z2 to Z5	Run
SP	-	Stop (interrupt)
SC	-	Stop and reset

Table 2-10 Data entry instructions

Instruction code	Numeric range	Function/Unit
FR	0.009 to 29.9999 (30)	Frequency (MHz)
IA	0 to 40	IF attenuation (dB) (Autoranging switched off)
RA	0 to 140	RF attenuation (dB) (Autoranging switched off)
TS	0.005 to 1000	Meas. time (s)
SA	0.009 to 29.9999	Start frequency (MHz)
SO	0.009 to 29.9999	Stop frequency (MHz)
SE	0 to 29.9999	Step size (MHz)
	0.01 to 100	Step size (%)
SU	-140.0 to 200.0	Max. level (dB)
SL	-140.0 to 200.0	Min. level (dB)
ST	1 to 9	Store
RC	0 to 9	Recall
SF *)	00 10, 11 20, 21 22, 23 24, 25 30, 31 40, 41 42, 43 44, 45 50, 51 52, 53 60, 61 62 63 64 65 66 70, 71 80, 81 90, 91	Cancel all spec. func. Level m m+ m- Offset Spec. Δf func. $\Delta f+$ $\Delta f-$ Automatic scan repetition (51) Step size linear, logarithmic (53) Lin. X axis, log. X axis (61) Recorder coding: Coding via <u>58</u> enabled Coding via <u>58</u> disabled = no recorder Disabled: YT recorder Disabled: XY recorder Disabled: ZSG 3 Polygonal curve, frequency line spectrum Indication of the electrical field strength, magnetic field strength (with correction -51.5 dB) Frequency scan, normal, fast (91)

*) Re: Spec. Func.:

The code numbers on the left apply at basic setting (= RCL0, SDC, DCL) with one exception: at RCL0 etc. always automatically level measurement SF11 is switched on.

Table 2-11 Direct instructions

Instruction code	Function
U0 U1	Off Send EOI with last On data byte (delimiter)
X1	Trigger command (= GET)
Y0 Y1	Off Recorder code disabled On enabled
Z0 Z1	Off Antenna/probe code disabled On enabled
P0 P1	Without "Data ready" for SRQ With
J0 J1	Off SRQ upon pressing ENTR Key 18 On in the local state of the ESH 3
V1	Format advance at recorder output 58
WZ 00 to 31	Delimiter in talker operation (Decimal equivalent of ASCII character)
WT a1 to a13	Text output on 13-digit display (upper-case letters and figures)
H0 H1	Pen lift at recorder output 58 Pen down
BP	Trigger beep
XP 0 to 1023	D/A converter: load X register
YP 0 to 255	D/A converter: load Y register

Basic setting at RCL0, SDL, DCL: U1, Y1, Z1, P1, J0, WZ13, H0, XP0, YP0

Generally, the following applies to all setting instructions:

All the commands received are checked for correct syntax and compatibility with the current device setting, and all the data received are checked to see that they are within the limit values. If errors are found these settings will not be executed and instead Service Request, with the appropriate code of the status byte, is generated (see section 2.3.21.6).

After the commands "J1" and GTL (Go to local) have been issued, a Service Request (SRQ) is generated with the status byte 84 at the push of the ENTR key 18, so as to send an acknowledgement to the IEC-bus controller even from remote test sites. After the command "J0" has been issued an SRQ is not issued at the push of the ENTR key.

2.3.21.4 Data Output

Data output of the ESH 3 in the Talk Only mode to a printer or another Listen Only device has been described in section 2.3.16. The following describes the data output when the memory is addressed via the IEC-bus controller.

Depending on the setting of the special function key 11 different data are output. These data are identified by two letters. Order of sequence, data output format and the units (not sent at the same time) are always fixed. The output is terminated with the programmed delimiter and - if set to do so - the END message.

Between the identification letters and the actual data there is a space (SP) which is replaced by an appropriate letter code, when the input is below the measurement range or exceeds it and in the case of overloading, in order to define the device status.

Table 2-12 Device status

Code	Definition
Space	Valid data
H	Data exceeds measurement range
U	Data falls below measurement range
X	Overload

The current receiver frequency setting is only output in automatic scanning operation. The first identification letter output with the level defines the antenna or probe connected, if any, and the second identification letter serves for coding the unit of measurement which has been set.

Table 2-13 Data format

Quantity to be measured		Code data	Unit
1	Frequency	FR 12.3456	MHz
2	Level	VL 123.4	dB μ V, dB
	Voltage	VN 1.23E + 03	
	Power	VM -123.4	dBm
	RF current	CL 123.4	dB μ A
		CN 1.23E + 03	μ A
	Electr. field strength	EL 123.4	dB μ V/m
		EN 1.23E + 03	μ V/m
	Magn. field strength	ML 123.4	dB μ A/m
		MN 1.23E + 03	μ A/m
3	AM Modulation depth	AM 34	%
4	Pos. modulation peak	AP 56	%
5	Neg. modulation peak	AN 12	%
6	Freq. offset	OS 1.23	kHz
7	Freq. deviation	DF 0.34	kHz
8	Pos. peak deviation	DP 0.56	kHz
9	Neg. peak deviation	DN 0.12	kHz

In the LIN.TEST and MAX. MIN. modes two quantities separated by a comma are output in one string (= single addressing of the ESH 3 as a talker).

Both quantities have a fixed character length:

LIN.TEST: 6+4 characters Example: VL -15.6, +0.1

MAX. MIN: 6+4 characters Example: VM -102.3,-108.6

To read out several SPEC.FUNC. results the ESH 3 must be addressed as a talker for each quantity to be measured. This is also true for the output of frequency and level in automatic scanning operation. A new SPEC. FUNC. result is output only after the required measuring time has elapsed.

2.3.21.5 Group of Addressed and Universal Commands

2.3.21.5.1 Remote/Local

If the Test Receiver ESH 3 receives its listener address from a controller it will switch over to REMOTE operation and remain in this state even after completion of the data transfer. All the operating controls on the front panel are disabled in the remote state - LED 24 lights up to indicate this state. If the ESH 3 receives the command GTL (Go to Local) or if the key LOCAL 24 is pressed it switches over again to the local state, i.e. the ESH 3 can again be set manually.

The LOCAL key can be disabled by issuing the controller command LLO (Local Lockout).

2.3.21.5.2 Device Clear

If the IEC-bus controller sends the universal command DCL (Device Clear) or the addressed command SDC (Selected Device Clear), the ESH 3 assumes its basic setting (see 2.2.3). The basic setting can also be selected through the IEC-bus instruction "RCO" or by pressing the keys RCL \emptyset (16 and 32).

Basic setting for the functions according to table 2-11:

U1, Y1, Z1, P1, J \emptyset , WZ13, H \emptyset , XP \emptyset , YP \emptyset .

2.3.21.5.3 Device Trigger

On receiving the addressed command GET (Group Execute Trigger) the ESH 3 starts immediately with the set or programmed test routine. This trigger command corresponds to the IEC-bus instruction "X1".

Table 2-14 lists examples of IEC-bus instruction output, the IEC-bus address being assumed to be 17.

Table 2-14

General IEC-bus instructions

Instruction	PPC	hp 9835/45	hp 9825	Tektronix 4051
Go to local	IECLAD 17 IECGTL IECUNL	LOCAL 7 ¹ or LOCAL 7 ⁺)	lcl 7 ¹ lcl 7 ⁺)	WBYTE @ 49,1,63:
Local Lockout	IECLLO	LOCAL LOCKOUT 7	llo 7	WBYTE @ 17:
Device Clear	IECDCL	RESET 7	clr 7	WBYTE @ 20:
Selected Device Clear	IECLAD17 IECSDC IECUNL	RESET 717	clr 717	WBYTE @ 49,4,63:
Group Execute Trigger	IECLAD 17 IECGXT IECUNL	TRIGGER 717	trg 717	WBYTE @ 49,8,63:
Parallel Poll Configure	IECLAD17 IECPPC IECPPE s ₁ s ₂ IECUNL	PPOLL CONFIGURE 717; mask	polc 717, mask	--
Parallel Poll Unconfigure (universal)	IECPPU	PPOLL UNCONFIGURE 7	plu 7	--
Parallel Poll Unconfigure (addressed)	IECLAD 17 IECPPD IECUNL	PPOLL UNCONFIGURE 717	plu 717	--
Parallel Poll	IECPPL v%	PPOLL (7)	pol (7)- A	--
Serial Poll	IECSPL 17, s%	STATUS 717; s	rds (717) - A	POLL A,S;17

+)

LOCAL 7 switches off the REMOTE line.

Prior to issuing new IEC-bus instructions, the REMOTE line must be reactivated with REMOTE 7.

2.3.21.6 "Service Request" and "Parallel Poll"

The Test Receiver ESH 3 is an autonomous IEC-bus device, i.e. it receives instructions from the controller, processes them without any further support and after execution of the instructions sends an asynchronous Service Request to the controller; which in the meantime can be used for other tasks. The device status byte which the controller receives through the Serial Poll serves not only to acknowledge the measurement process but also for coding a specific device status.

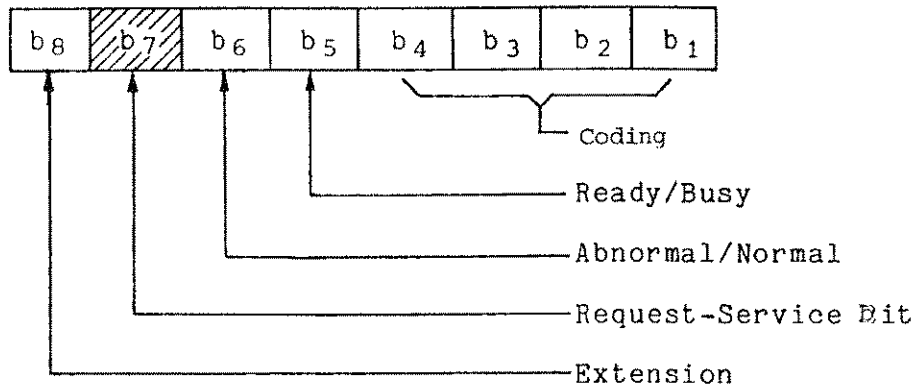

Fig. 2-7 Status byte

Service Request upon termination of a measuring process or a calibration process can be suppressed by means of IEC-bus instructions (P0, P1).

Table 2-15 Coding of Ready/Busy (Bit 5)

Device status	Status byte	Decimal
Meas. process terminated	0 1 0 1 0 0 0 0	80
Calibration terminated	0 1 0 1 0 0 0 1	81
Scan terminated	0 1 0 1 0 0 1 0	82
ENTR key presses	0 1 0 1 0 1 0 0	84

Table 2-16 Coding of Abnormal/Normal (Bit 6)

Device status	Status byte (dec.)	Error code Table 2-6
Syntax error in IEC-bus instruction	96	-
IEC setting instruction incompatible with current device setting	97	-
Data above limit	98	01
Data below limit	99	02
Memory register not occupied if RCL	100	08
Level or offset calibration defective	101	05
CAL: Checking error	102	03
Correction value at CAL total > 6 dB	103	07
At start of an automatic frequency scanning operation one or more parameters are not defined.	104	20 to 25
Start frequency > stop frequency	105	30
Start frequency = stop frequency and XY recorder or ZSG 3 connected	106	31
Max. level \leq min. level	107	33
SF61 (log. X axis) and $\frac{f_{STOP}}{f_{START}} < 1.4$	100	33
SF61 (log. X axis and ZSG 3	109	40
Faulty synthesizer synchronization	110	51 to 55
Faulty supply voltages	111	10 to 14
Talker mode: no listener at IEC bus	224	-

Parallel Poll

The ESH 3 can be configured so as to answer a Parallel Poll request sent from the IEC-bus controller via the primary command "PPC" and the subsequent secondary command "PPE", the latter consisting of 'X 1 1 0 S P₃ P₂ P₁'. The three least significant bits P₁ to P₃ define the data line, on which the answer is to be sent. The sense bit S together with the current device status "ist" (individual status bit) determines whether the answer sent is a "1" (ist = S) or a "0" (ist ≠ S).

NOTE: With the IEC-bus, "1" (i.e. true) corresponds to a low level on the data line.

Example: PPE = 01101010 assigns the bus data line DIO3.

Ist = "1" yields the PP answer "1".

The ist bit of the ESH 3 is identical with the Ready/Busy bit 5 of the status byte in a Serial Poll, i.e.

ist = 1 if data is ready

ist = 0 if measurement is not yet terminated.

This permits the IEC-bus controller to recognize the termination of the measuring process without the need for the relatively time-consuming Serial Poll.

Table 2-17 Setting the device address

ASCII character		Binary address					Decimal equivalent
Listen address	Talk address	Address switch S5 S4 S3 S2 S1					
(SPACE)	a	0	0	0	0	0	0
!	A	0	0	0	0	1	1
"	B	0	0	0	1	0	2
	C	0	0	0	1	1	3
§	D	0	0	1	0	0	4
%	E	0	0	1	0	1	5
&	F	0	0	1	1	0	6
	G	0	0	1	1	1	7
(H	0	1	0	0	0	8
)	I	0	1	0	0	1	9
*	J	0	1	0	1	0	10
+	K	0	1	0	1	1	11
, comma	L	0	1	1	0	0	12
-	M	0	1	1	0	1	13
.	N	0	1	1	1	0	14
/	O	0	1	1	1	1	15
0	P	1	0	0	0	0	16
1	Q	1	0	0	0	1	17*)
2	R	1	0	0	1	0	18
3	S	1	0	0	1	1	19
4	T	1	0	1	0	0	20
5	U	1	0	1	0	1	21
6	V	1	0	1	1	0	22
7	W	1	0	1	1	1	23
8	X	1	1	0	0	0	24
9	Y	1	1	0	0	1	25
:	Z	1	1	0	1	0	26
;		1	1	0	1	1	27
<		1	1	1	0	0	28
=		1	1	1	0	1	29
>		1	1	1	1	0	30

*) Factory set

Table 2-18 ASCII Code

(SENT AND RECEIVED WITH ATN=1)

Bits	b ₇	b ₆	b ₅	b ₄	b ₃	b ₂	b ₁	MSG	0 0 0	0 0 1	MSG	0 1 0	MSG	0 1 1	MSG	1 0 0	MSG	1 0 1	MSG	1 1 0	MSG	1 1 1	MSG
	b ₇	b ₆	b ₅	b ₄	b ₃	b ₂	b ₁		0	1		2	3	4	5	6	7						
									0	1		2	3	4	5	6	7						
									NUL	DLE	SP	Ⓢ	Ⓢ	Ⓢ	Ⓢ	Ⓢ	Ⓢ	P	Q	R	S	T	
									SOH	DC1	Ⓢ	Ⓢ	Ⓢ	Ⓢ	Ⓢ	Ⓢ	Ⓢ	A	B	C	D	E	
									STX	DC2	"	#											
									ETX	DC3													
									EOT	DC4	\$	%	&	'	()	*	+	,	-	.	/	
									ENQ	NAK	PPU	Ⓢ	Ⓢ	Ⓢ	Ⓢ	Ⓢ	Ⓢ	Ⓢ	Ⓢ	Ⓢ	Ⓢ	Ⓢ	
									ACK	SYN	Ⓢ	Ⓢ	Ⓢ	Ⓢ	Ⓢ	Ⓢ	Ⓢ	Ⓢ	Ⓢ	Ⓢ	Ⓢ	Ⓢ	
									BEL	ETB	Ⓢ	Ⓢ	Ⓢ	Ⓢ	Ⓢ	Ⓢ	Ⓢ	Ⓢ	Ⓢ	Ⓢ	Ⓢ	Ⓢ	
									BS	CAN	()	*	+	,	-	.	/	UNL				
									HT	EM	Ⓢ	Ⓢ	Ⓢ	Ⓢ	Ⓢ	Ⓢ	Ⓢ	Ⓢ	Ⓢ	Ⓢ	Ⓢ	Ⓢ	
									LF	SUB	Ⓢ	Ⓢ	Ⓢ	Ⓢ	Ⓢ	Ⓢ	Ⓢ	Ⓢ	Ⓢ	Ⓢ	Ⓢ	Ⓢ	
									VT	ESC	Ⓢ	Ⓢ	Ⓢ	Ⓢ	Ⓢ	Ⓢ	Ⓢ	Ⓢ	Ⓢ	Ⓢ	Ⓢ	Ⓢ	
									FF	FS	Ⓢ	Ⓢ	Ⓢ	Ⓢ	Ⓢ	Ⓢ	Ⓢ	Ⓢ	Ⓢ	Ⓢ	Ⓢ	Ⓢ	
									CR	GS	Ⓢ	Ⓢ	Ⓢ	Ⓢ	Ⓢ	Ⓢ	Ⓢ	Ⓢ	Ⓢ	Ⓢ	Ⓢ	Ⓢ	
									SO	RS	Ⓢ	Ⓢ	Ⓢ	Ⓢ	Ⓢ	Ⓢ	Ⓢ	Ⓢ	Ⓢ	Ⓢ	Ⓢ	Ⓢ	
									SI	US	Ⓢ	Ⓢ	Ⓢ	Ⓢ	Ⓢ	Ⓢ	Ⓢ	Ⓢ	Ⓢ	Ⓢ	Ⓢ	Ⓢ	

ADDRESSSED COMMAND GROUP (ACG)

UNIVERSAL COMMAND GROUP (UCG)

LISTEN ADDRESS GROUP (LAG)

TALK ADDRESS GROUP (TAG)

PRIMARY COMMAND GROUP (PCG)

SECONDARY COMMAND GROUP (SCG)

- NOTES:
- ① MSG = INTERFACE MESSAGE
 - ② b₁ = D101...b₇ = D107
 - ③ REQUIRES SECONDARY COMMAND
 - ④ DENSE SUBSET (COLUMN 2 THROUGH 5)

2.4 Examples of Measurements

2.4.1 Measurement of Sinewave Signals

See also sections 2.3.4 and 2.3.11

2.4.1.1 Measurement Accuracy (Noise Effects)

The measurement accuracy of a test receiver is mainly determined by the accuracy of the calibration level (error < 0.5 dB), the accuracy of the RF and the IF level switch (error < 0.3 dB), and the linearity of the meter rectifier (error < 0.1 dB) and the logarithmic conversion (in the 40-dB and the 60-dB operating range). These parameters are extremely stable with the ESH 3 based on very exacting tests, so that the measuring error is less than 1 dB in the 20-dB operating range. The maximum measuring error is slightly higher (by about 0.3 dB) in the 40-dB and the 60-dB operating ranges. In practice, however, the measuring error is much less. The smallest frequency step size of 100 Hz introduces an additional maximum level error of 1.5 dB with the 200-Hz IF bandwidth selected.

In addition, the measurement accuracy is influenced by the inherent receiver noise. The error introduced is relatively small with average-value indication but considerably more pronounced with peak-value indication. The influence of the inherent receiver noise is expressed by the following formulae:

With average-value indication

$$\text{Error/dB} = 20 \log \sqrt{1 + 10^{-\frac{(S - N_1)/\text{dB}}{10 \text{ dB}}}}$$

(with sufficiently long averaging times ≥ 0.1 s)

With peak-value indication

$$\text{Error/dB} = 20 \log \left(1 + 10^{-\frac{(S - N_2)/\text{dB}}{20 \text{ dB}}} \right)$$

where

S = level of an unmodulated sinewave signal in dB(μ V)

N1 = noise with average-value indication in dB(μ V)

N2 = noise with peak-value indication, $N_2 \approx N_1 + 11$ dB.

Fig. 2.8 and the following table give the reading error due to noise with average-value and peak-value indication as a function of the signal-to-noise ratio.

Table 2-19

S/N ratio	Average value	Peak value
S-N1/dB	dB	dB
0	3,01	13,15
1	2,53	13,38
2	2,12	13,63
3	4,76	13,91
4	5,45	14,20
5	6,19	14,52
6	6,97	14,87
7	7,79	15,24
8	8,63	15,64
9	9,51	16,07
10	10,41	16,53
11	11,33	17,02
12	12,26	17,53
13	13,21	18,07
14	14,61	18,64
15	15,13	19,24
16	16,10	19,87
17	17,08	20,52
18	18,06	21,20
19	19,05	21,91
20	20,04	22,63
22	22,02	24,15
24	24,01	25,75
26	26,01	27,42
30		30,92
40		40,30
50		50,09

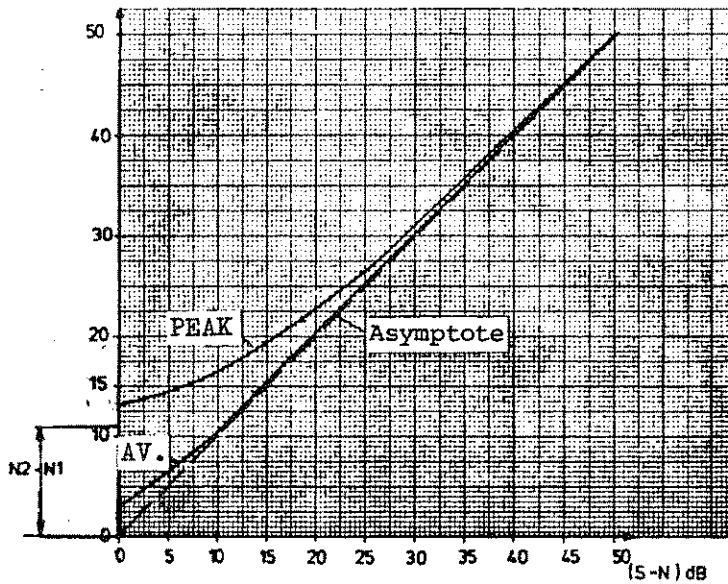

Fig. 2-8 Reading error of an unmodulated sinewave signal due to noise with average-value and peak-value indication as a function of the signal-to-noise ratio.

Table 2-20

Error when measuring an unmodulated sinewave signal with peak-value indication as a function of the signal-to-noise ratio S-N2.

S-N2	$\text{Error} = 20 \lg \left(1 + 10^{-\frac{(S-N2)/\text{dB}}{20 \text{ dB}}} \right) \text{dB}$
0 dB	6.02 dB
1	5.53
2	5.08
3	4.65
4	4.25
5	3.88
6	3.53
7	3.21
8	2.91
9	2.64
10	2.39
11	2.16
12	1.95
13	1.75
14	1.58
15	1.42
16	1.28
17	1.15
18	1.03
19	0.93
20	0.83
22	0.66
24	0.53
26	0.42
28	0.34
30	0.27
32	0.22
34	0.17
36	0.14
38	0.11
40	0.09
45	0.05
50	0.03

Table 2-21

S-N 1	Error = 20 lg	$\frac{(S-N1)/dB}{1+10^{-\frac{(S-N1)/dB}{10}}}$ dB
0 dB	3.01 dB	
1	2.54	
2	2.12	
3	1.76	
4	1.46	
5	1.19	
6	0.97	
7	0.79	
8	0.64	
9	0.51	
10	0.41	
11	0.33	
12	0.27	
13	0.21	
14	0.17	
15	0.13	
16	0.11	
17	0.09	
18	0.07	
19	0.05	
20	0.04	
21	0.03	
22	0.03	
23	0.02	
24	0.02	
25	0.01	

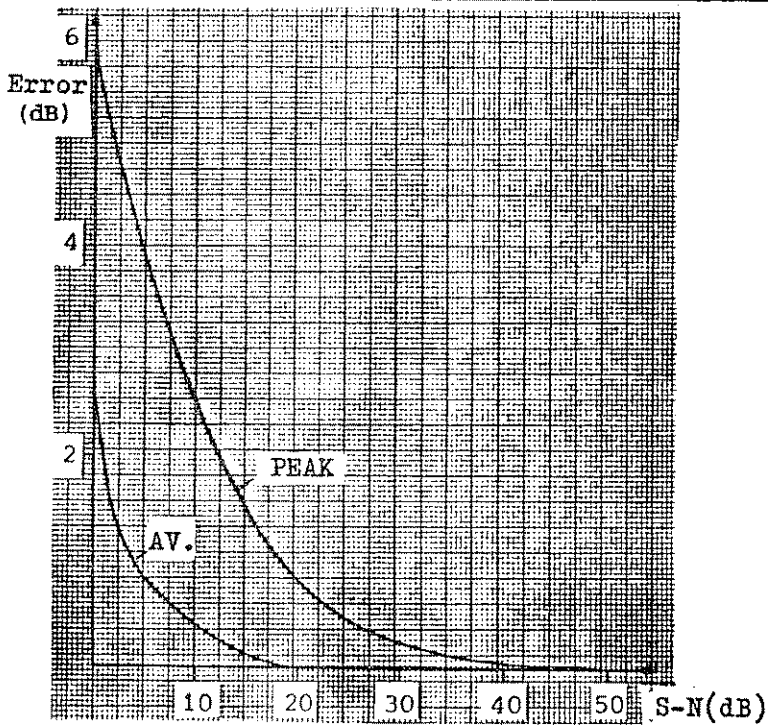

Fig. 2-9 Reading error due to noise with average-value and peak-value indication.

Two rules can be derived from these relationships:

- For a high measurement accuracy the highest possible signal-to-noise ratio must be ensured, i.e. the highest possible IF attenuation must be cut in. However, when measuring signals with extremely different levels section 2.4.7 should be observed.
- Average-value indication is always preferable when measuring the level of CW signals. Average-value indication also offers high suppression of interference pulses (see section 2.3.4).

2.4.1.2 Influence of Amplitude Modulation

According to the definition of the indicating modes in section 2.3.4 the peak-value indication increases with the modulation depth as against the average-value indication.

With a sufficiently high signal-to-noise ratio the function shown in Fig. 2-8 holds for the increase in the peak-value indication as against average-value indication with amplitude modulation.

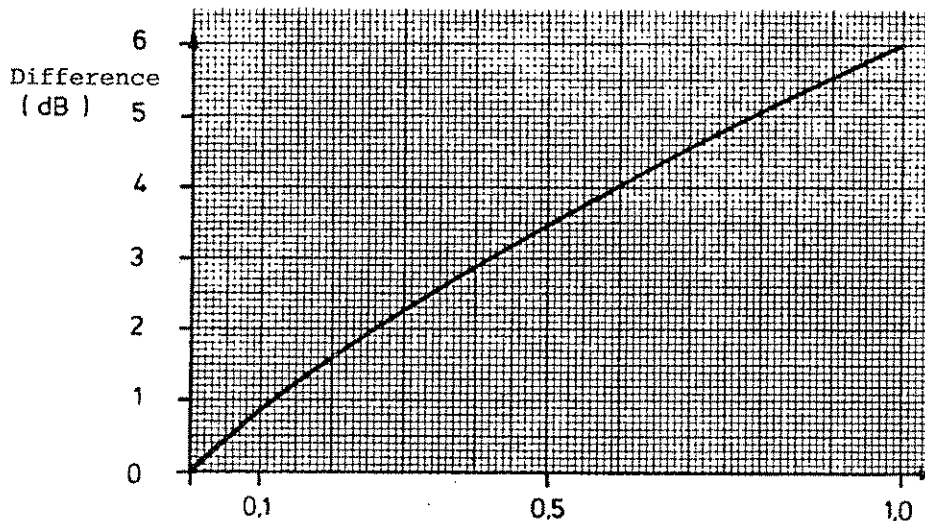

Fig. 2-10 Increase in peak-value indication as against average-value indication with amplitude modulation.

This function is only true in the 20-dB operating range, but not in the 40- and the 60-dB operating range, where an instantaneous logarithmic conversion of the IF signal takes place. As a result, a distorted envelope is obtained at the output of the logarithmic converter with amplitude

modulation, which causes a decrease in the indication of the average value. In the following table and Fig. 2-11 this decrease in the indication of the average value is shown as a function of the modulation depth.

Table 2-22

Modulation depth	Decrease in indication
0	0 dB
0,1	-0,022
0,2	-0,088
0,3	-0,202
0,4	-0,370
0,5	-0,602
0,6	-0,915
0,7	-1,340
0,8	-1,938
0,9	-2,878
1	-6,021

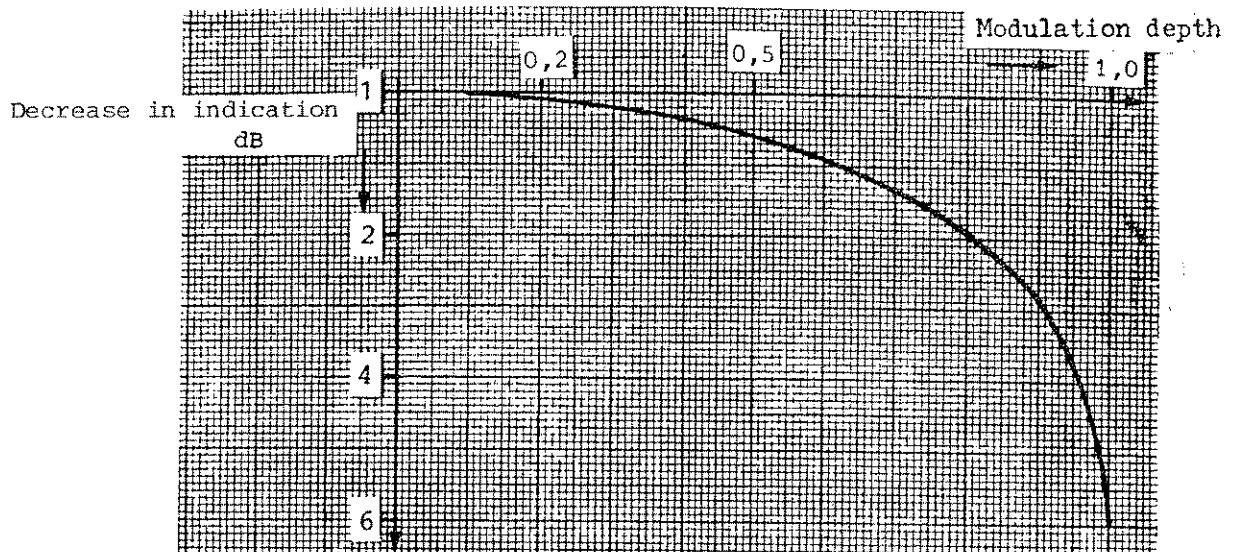

Fig. 2-11 Decrease in indication of average value when measuring amplitude-modulated signals.

As shown in Fig. 2-11 the error is practically negligible below a modulation depth of 50% but is considerable with a modulation depth of 100%.

2.4.1.3 Measurement of Frequency Offset and Deviation

By its nature the frequency-offset measurement (= offset of test signal from receiver frequency) is an average-value measurement. It is therefore, as pointed out in section 2.4.1.1, not as susceptible to the signal-to-noise ratio as the deviation measurement which involves two peak-value measurements. For the measurement of the frequency deviation it is always the peak deviation within the given measuring time which is determined. Frequency offset and deviation are measured as special functions (see section 2.3.13).

Further analyses can be made via the outputs FM 51 and FREQ. DEV. 54 on the rear panel. The output FREQ. DEV. 54, the output voltage of which is covered by the offset calibration, can, for example, be used to record the drift of a transmitter. It is, however, also possible to connect to it an rms-responsive AF voltmeter, with or without weighting filter, for measuring frequency deviation or spurious deviation.

For remote frequency measurement section 2.3.12 should be observed using a precise frequency counter, such as the Philips PM 6615, connected to the output GEN. 44.

2.4.1.4 Measurement of Modulation Depth

The modulation depth can be measured by means of the special function "modulation depth" (see section 2.3.13). Here too it should be borne in mind that the modulation depth measurement is a peak-value measurement which calls for a high signal-to-noise ratio.

The AM output 50 and the IF output 48 can be used for further investigations. It is also possible to measure the rms modulation depth by connecting an rms-responsive AF voltmeter to the AM output 50.

2.4.2 Measurement of Pulse Signals and Broadband Noise

The pulse signals here referred to are signals whose spectrum is considerably wider than the IF bandwidth and whose individual spectral lines can not be resolved by the IF filter. In contrast, keyed carriers have a narrow-band characteristic; even if their level cannot be measured with average-value indication it can be measured with peak-value indication.

2.4.2.1 Interference Measurement According to VDE and CISPR

With the CISPR indicating mode (see section 2.3.4) the correct pulse weighting is automatically selected for the frequency set:

In the range 9 to 149.9 kHz the weighting is in accordance with CISPR 3 and in the range 150 kHz to 30 MHz the weighting is in accordance with CISPR 1.

The measuring time is selectable between 0.005 and 100 s. The standard measuring time is 1 s. The reason for the relatively long measuring time of 1 s as a lower limit is the time constants required by CISPR, viz. the discharge time constant and the time constant of the filter provided for the simulation of the meter response. The ESH 3, however, relieves the user of the chore of observing the maximum pointer deflection. It determines the maximum analog voltage over the measuring time and reads out this value as the test result.

If slowly varying components are dominant in the interference signal the variation of the weighted analog voltage can be watched on the analog indication 14. Autoranging takes a little longer in the CISPR indicating mode. Nevertheless, autoranging is the only reliable method for measuring interference spectra over a wide dynamic range with automatic frequency scanning. Low-noise mode measurements can be carried out over the entire frequency range of the ESH 3. In particularly critical cases, for example, when measuring forms of interference whose spectrum falls very sharply with increasing frequency, the reliability of the test can be enhanced by carrying out the linearity test.

The Artificial Mains Network ESH 2-Z5 (IN 338.5219.52) permits interference voltage measurements on AC-supply-dependent, interference-creating loads. For automatic phase switching the Artificial Mains Network can also be remote-controlled via an IEC-bus-compatible controller, such as the PPC, with the aid of the Code Converter PCW.

For further interference voltage measurements the high-impedance Active Probe ESH 2-Z2 and Passive Probe ESH 2-Z3 are available.

The Clamp-on RF Current Probe ESH 2-Z1 is used for measuring interference currents on lines. With the Inductive Probe HFH 2-Z4 the source of interference can be located.

The Loop Antennas HFH 2-Z2 and HFH 2-Z3 and the Rod Antenna HFH 2-Z1 permit the field strength of the radio interference to be measured. The ESH 3 can drive either a printer (in the Talk Only mode) or an XY recorder for data logging in automatic scanning operation. The recorder output with a logarithmic frequency axis (special function: 61) is here particularly useful since most of

the limit values for radio interference are represented with a logarithmic frequency axis. Use of paper preprinted with the limit values is recommended.

2.4.2.2 Measurement of Broadband Interference in Accordance with MIL Standards and VG Regulations

For these measurements the indicating mode MIL must be used in which all interference levels are output as a pulse spectral density relative to a bandwidth of 1 MHz. With reference to section 2.3.4, it is always best to use the maximum permissible test (IF) bandwidth laid down in the standards since here the bandwidth is not rigidly interlinked with weighting as is the case with CISPR radio interference measurements. The antennas and probes required to meet the standards are available from R&S.

For measuring narrow-band interference average-value indication is preferable for its many advantages it offers (see section 2.3.4).

In automatic scanning operation, the ESH 3 can drive either a printer (in the Talk Only mode) or an XY recorder for data logging. The recorder output with a logarithmic frequency axis (special function: 61) is very useful for this purpose too since the limit values can almost always be represented as straight lines using a logarithmic frequency axis. The continuous characteristic of broadband interference spectra makes it readily possible to enter step sizes B_{IF} . It is preferable to use a longer measuring time for each individual measurement than to obtain many varying individual test results. If necessary a special detailed measurement can be carried out in the proximity of the spectrum peak.

Use of paper preprinted with the limit values is recommended.

2.4.3 Measurement of Varying Signals With the Indicating Mode MAX. MIN.

This indicating mode serves mainly for measuring field-strength variations due to fading. In most cases average-value indication is used for the measurement (CW signals) but peak-value indication is used too (SSB signals and keyed carriers).

Even though there are no regulations specifying this, the indicating mode MAX. MIN. can also be used to advantage for evaluating the disturbing effect of broadband interference. In these cases, the individual measurements must be carried out with either of the CISPR or MIL indicating modes.

Since autoranging is not possible with MAX. MIN. as pointed out in section 2.3.4, automatic frequency scanning is also not possible. For these same reasons output to a recorder is not possible with MAX. MIN.

2.4.4 Twoport and Reflection-coefficient Measurement

In the operating mode TWOPORT 38 the output of the tracking generator GEN. 44 supplies a voltage of 80 dB (μV) into 50 Ω at the receiver centre frequency. This voltage permits the magnitude of the gain or attenuation of twoport networks between the output GEN. 44 and the input RF 45 to be measured.

With the aid of a VSWR bridge, such as Model 68 BF 50 from WILTRON, the return loss of two-terminal networks can also be readily measured.

Since the graphic display of the frequency response is of great interest in both cases the output to an XY recorder is very useful.

Example: Measurement on a band-pass filter

To this end the entire frequency range over which the filter is to be measured can be divided into five subranges with different step size. The step size is narrow at the steep edges and wider in the pass band and stop band, thus optimum recording times are achieved.

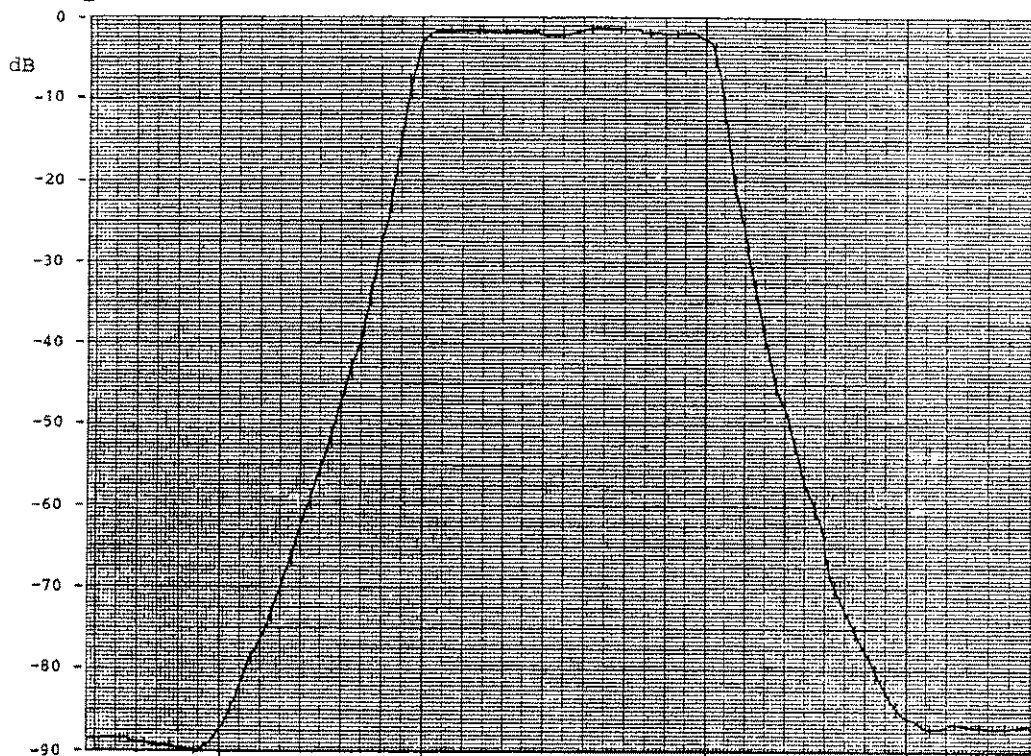

10.65 MHz

10.75 MHz

Fig. 2-12 Division of pass-band characteristic into five subranges. The vertical lines mark the step sizes.

For measurement of the return loss, the insertion loss between the output GEN. 44 and the input RF 45, with the output of the device under test short-circuit or open-circuit is described as "0-dB return loss" and entered as maximum level. For the minimum level a value 40 dB less (depending on the accuracy of the bridge used) is entered. From the return loss a_r in dB the reflection coefficient is obtained:

$$r/\% = 10^{\frac{-a_r}{20}} \times 100.$$

Example:

The insertion loss between the output GEN. 44 and the input RF 45 without load is 6.5 dB. The maximum return loss of a test item is 40 dB. Hence,

the maximum level to be entered -6.5 dB and
the minimum level to be entered -46.5 dB.

The recording paper should be provided with a reflection-coefficient scale on the Y axis.

2.4.5 Remote Frequency Measurement

For remote frequency measurement a frequency counter is connected to the ESH 3 in the operating mode REM. FREQ. 38. This is one of the few measurements where automatic frequency scanning is not possible since - even though there are frequency counters with Talk Only capability - the print control cannot be synchronized between the ESH 3 and the frequency counter. For this reason, an IEC-bus controller, such as the PPC, must be used for automatic measurements, which starts the measuring process of the frequency counter at defined instants.

For manual remote frequency measurements of signals with considerably varying amplitude, or keyed signals, the analog voltage at the output AV/PEAK 53 can be converted into a TTL level to trigger the frequency counter.

2.4.6 Measurement of Harmonics, Non-harmonic Spurious Signals and Sideband Noise

2.4.6.1 Measurement of Harmonics

Thanks to its linearity (cf. 2nd order harmonic distortion rating in the Technical Information) the ESH 3 is ideally suited for measuring oscillator and transmitter harmonic distortion. A frequency step size equal to the frequency of the fundamental is chosen for automatic frequency scanning. Thus it is possible to represent the level lines of the fundamental and the harmonics together on an XY recorder. To be on the safe side, low-distortion measurement (LOW DIST. 42) (possibly with LIN. TEST 39) should be selected. Indicating mode: AV.; operating range 20 dB; IF bandwidth to suit the stability of the fundamental.

2.4.6.2 Measurement of Non-harmonic Spurious Signals

Automatic frequency scanning and recorder output make the ESH 3 also particularly suitable for measuring non-harmonic spurious signals. In contrast to manual frequency scanning, automatic scanning permits an accurate record to be made of the suppression of non-harmonic spurious signals.

2.4.6.3 Measurement of Sideband Noise

Thanks to the low sideband noise of the oscillators and the high selectivity of the IF filters in the ESH 3, measurements in the vicinity of the carrier at high levels are readily possible (cf. section 2.3.3, Fig. 2-1). The effective selectivity of the 500-Hz filter can be further enhanced as described in section 2.3.3. For measurement of the sideband noise with conversion into dB/Hz the 3-dB IF bandwidths of the ESH 3 should be borne in mind in the calculation. Spurious deviation can also be measured with the aid of the special function "Freq. deviation" if no weighting filters are required for the measurements.

2.4.7 Linearity Measurements on Amplifiers and Tuners (Compression, Intermodulation, Cross Modulation)

The excellent linearity of the ESH 3 makes it also particularly suitable for linearity measurements on active components. The measurements must, however, be carried out with the aid of signal generators that

- supply sufficiently high levels;
- allow adequate fine variation of the output level, and
- feature a remote-control connector in accordance with IEC-625.1 (IEEE 488) for automatic measurements.

The built-in linearity-test facilities (LIN. TEST 39) of the ESH 3 prevent virtually any measuring errors due to non-linearity. The automatic linearity test can also be triggered and evaluated by the computer.

Since several devices are always involved in a linearity measurement automatic measurements are only possible with the aid of a computer.

- Measurement of compression: The test item input level is increased until 1-dB compression is obtained.
- Measurement of intermodulation (e.g. 3rd order IM products): The level of the signals from two signal generators at the test item input is increased until an intermodulation product can be measured with the ESH 3.
- Measurement of cross modulation: The level of a 30% amplitude-modulated signal generator is increased until an AM of 3% can be measured on a second signal generator with an unmodulated carrier. For spurious modulation measurement tune the ESH 3 to one of the two modulation sidebands at 200 Hz IF bandwidth.

For all linearity measurements the minimum IF attenuation and the maximum RF attenuation should be set on the ESH 3. In some cases, direct computer setting of the RF and the IF attenuation may prove still more effective for automatic measurements than autoranging with low-distortion measurement, as it is then possible to adjust the indicated voltage closer to the noise indication limit, thus minimizing the level at the 1st mixer.

2.4.8 Recording of Signals

All the following considerations are based on recording without an external computer. Information on data recording is also contained in sections 2.3.16, 2.3.17 and 2.3.19.

2.4.8.1 Recording of Signal Level and Frequency Offset as a Function of Time

The signal level as a function of time can be recorded in three different ways:

- a) Use of the outputs CISPR 52 for CISPR recording and AV/PEAK 53 for average-value and peak-value recording on a YT recorder. Measurements with the MIL indicating mode can also be made at output AV/PEAK 53. In contrast to the XY RECORDER output 58, these outputs offer the advantage that the output voltage follows the input voltage without any delay (to be exact, only with average-value indication since the peak-value hold time is always equal to the measuring time). On the other hand, these outputs have the drawback that fluctuations that require autoranging are not adequately recorded. Automatic scanning is not necessary in this case.
- b) Use of the output 58 for all level recordings on YT recorders. The Y output voltage changes with each new data output on the display 13. However, to trigger such a recording process, automatic frequency-scanning with $f_{\text{START}} = f_{\text{STOP}}$ is required. To stop this pseudo-automatic frequency scanning process the STOP key must be pressed twice.
- c) Data output to a printer in the Talk Only mode. Simultaneously with each output on the display 13 the data is output to the printer. This method produces less easy-to-grasp results than graphic methods but it offers the advantage of statistical data evaluation if no desktop calculator control is provided. The output to the printer is also triggered by automatic frequency scanning with $f_{\text{START}} = f_{\text{STOP}}$.
The start of this pseudo frequency scanning process initiates continuous printer output. Recording methods 2) and 3) are also possible simultaneously.

For recording the frequency offset as a function of time only the following methods are possible:

- Use of output 54 for output to an XY recorder without automatic scanning.
- Talk Only output of the measured data in automatic scanning operation with $f_{\text{START}} = f_{\text{STOP}}$ (31).

2.4.8.2 Recording of Signal Level as a Function of Frequency

The signal level as a function of frequency can be recorded in two different ways.

2.4.8.2.1 Output to an XY Recorder Via 58 With Automatic Frequency Scanning

This method was described in detail in section 2.3.19.

The following settings are recommended:

- a) Line spectra (SPEC. FUNC. 71) if the indicating mode AV. or PEAK has been selected and if the step size of scanning is wider than one-half of the IF bandwidth.
- b) Polygonal curves (SPEC. FUNC. 70) if
 - the indicating mode AV. or PEAK has been selected and the step size of scanning is narrower than or equal to one-half of the IF bandwidth.
 - the indicating mode CISPR or MIL has been selected, the step size having no influence.
 - the indicating mode TWOPORT has been selected.

2.4.8.2.2 Output to a Printer Via 57

Frequency values and the corresponding level values are printed out together. Further parameters can be printed out via special functions. Values below the minimum level are not printed out.

Output to a recorder and a printer is possible in parallel.

2.4.8.3 Recording of Frequency Band Occupancy as a Function of Time

Recording of frequency band occupancy as a function of time is only possible by output to one to five Radio Monitoring Recorders ZSG 3 as described in section 2.3.19 or by computer control. The recording threshold is determined by the minimum level entered.